

ZAFFERANO

CATALOGUE



Valdesign[®]
cucine



**IT ZAFFERANO,
UN TELAIO IN
ALLUMINIO
PER 124 DIVERSE
FINITURE
EN ZAFFERANO,
AN ALUMINIUM
FRAME FOR
124 DIFFERENT
FINISHES**

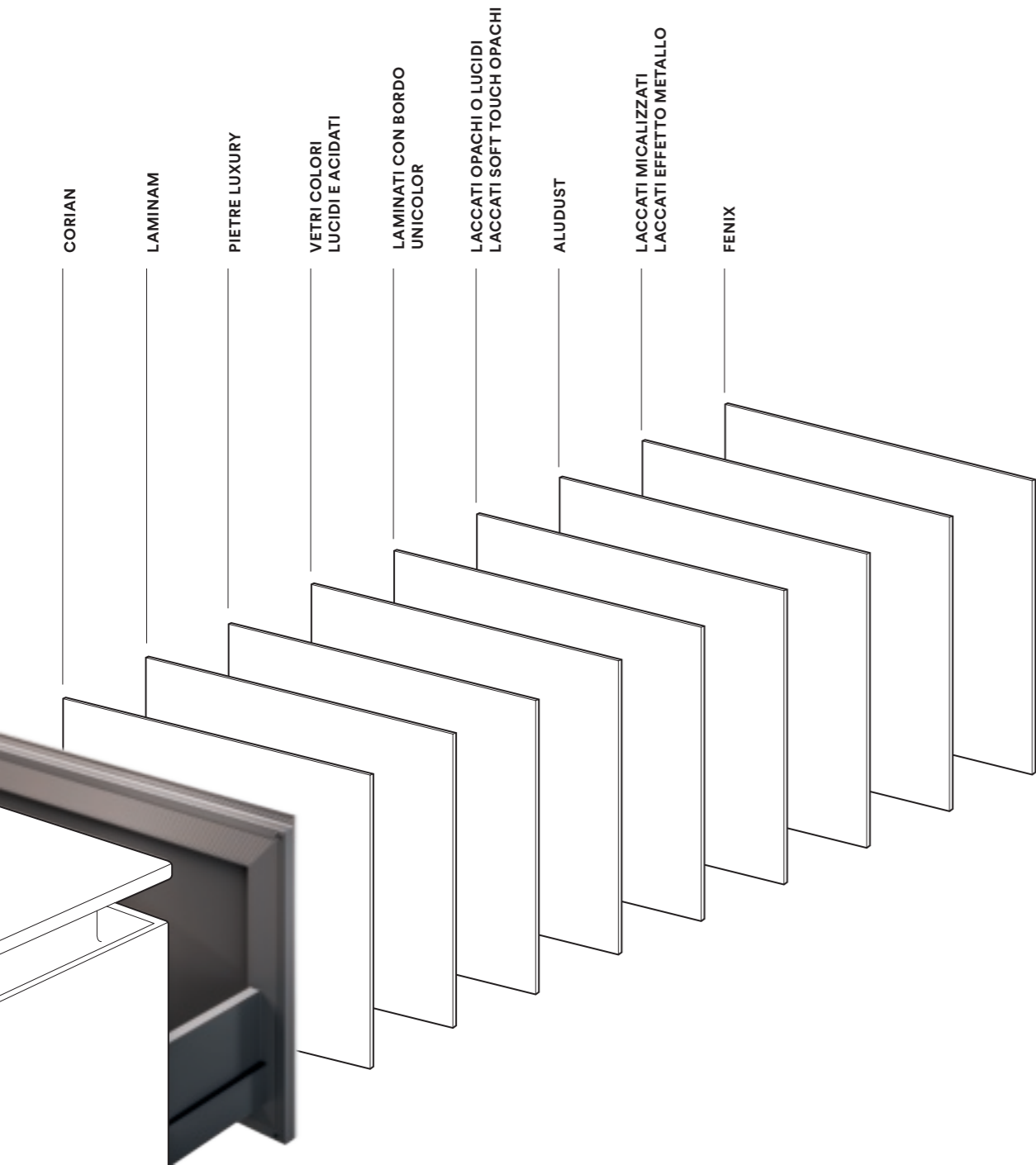

02
CORIAN
→ Corian



20
LAMINAM
→ Laminam



09
VETRI COLORI LUCIDI E ACIDATI
→ Etched and high-gloss coloured glass



35
LAMINATI CON BORDO UNICOLOR
→ Laminates with Unicolor edge



28
LACCATI OPACHI O LUCIDI
→ Matt or high-gloss lacquers



06
ALUDUST
→ Aludust



06
LACCATI MICALIZZATI E EFFETTO METALLO
→ Micalised lacquers and metal effect



08
FENIX
→ Fenix

05
LACCATI SOFT TOUCH OPACHI
→ Matt soft-touch lacquers

01
LACCATI EFFETTO METALLO SATINATO
→ Satin metal effect lacquers

IT INDICE
COMPOSIZIONI
ZAFFERANO
STRUTTURATO PER
CONFIGURAZIONE
ERGONOMICA
EN ZAFFERANO
COMPOSITIONS
ORGANISED BY
ERGONOMIC
CONFIGURATION

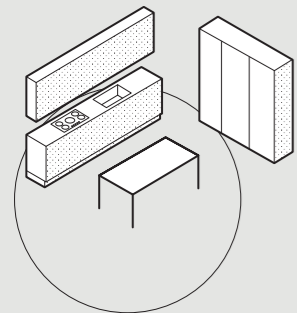

**COMPOSIZIONE LINEARE SOSPESA
CON BOISERIE E COLONNE**
→ wall-mounted linear composition with
boiserie and tall units

Z / 01 → pag. 6

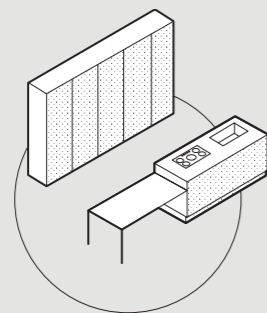

**COMPOSIZIONE COLONNE
CON ISOLA E TAVOLO INTEGRATO**
→ Tall unit composition
with island and built-in table

Z / 02 → pag. 18

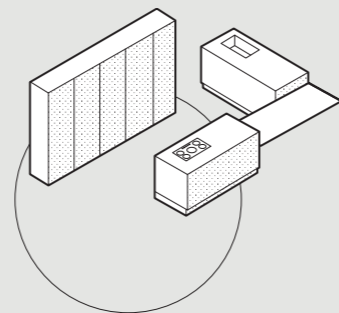

**COMPOSIZIONE COLONNE
CON ISOLA COMPOSTA**
→ Tall unit composition
with composite island

Z / 03 → pag. 28
Z / 05 → pag. 48

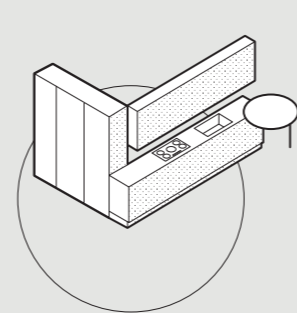

**COMPOSIZIONE AD ANGOLO
CON SNACK INTEGRATO**
→ Corner composition
with built-in breakfast bar

Z / 04 → pag. 40

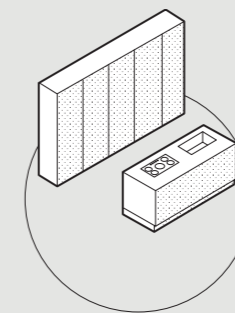

**COMPOSIZIONE COLONNE
CON ISOLA**
→ Tall unit composition
with island

Z / 06 → pag. 62

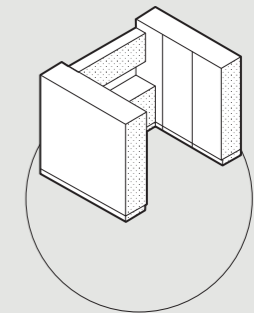

COMPOSIZIONE A "U"
→ U-shaped composition

Z / 07 → pag. 72

Z/01

IT COMPOSIZIONE LINEARE
SOSPESA CON BOISERIE
E COLONNE
EN WALL-MOUNTED LINEAR
COMPOSITION WITH
BOISERIE AND TALL UNITS





Tavolo Fusello e sedie Corium
Fusello table and Corium chairs
→ Cat. Complementi Alf DaFrè







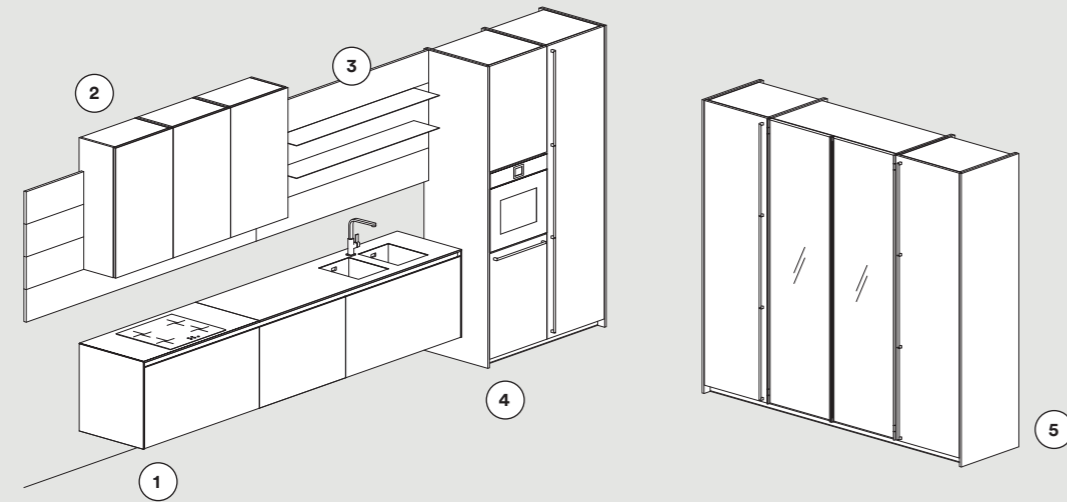

1 BASI / BASE UNITS
 Basi Aludust Ambra, gola Noce Naturale, zoccolo Laccato Soft Touch Nero, top e spalle Laminam Nero assoluto. / Base units Aludust Ambra, Groove Natural walnut, Plinth Nero Soft Touch lacquer, Top and side panels Nero Assoluto Laminam.

2 PENSILI / WALL UNITS
 Pensili Aludust Ambra. / Wall units Aludust Ambra.

3 BOISERIE
 Boiserie Noce Naturale, mensole metallo Moka Shine. / Boiserie Natural walnut, shelves Moka Shine metal.

4 COLONNE LOGICA / LOGICA TALL UNITS
 Colonne Logica Laccato Soft Touch Nero, zoccolo Laccato Soft Touch Nero, maniglia Laccato opaco Nero. / Logica tall units Nero Soft Touch lacquer, plinth Nero Soft Touch lacquer, handle Matt Nero lacquer.

5 COLONNE CANVAS / CANVAS TALL UNITS
 Colonne Canvas anta vetro trasparente grigio, telaio Moka Shine, scocca Laccato Soft Touch Nero, schiena Noce Naturale / Canvas tall units Grigio transparent glass door, Moka Shine frame, body Nero Soft Touch lacquer, Back panel Natural walnut.



Basi / Base units

Colonne / Tall units

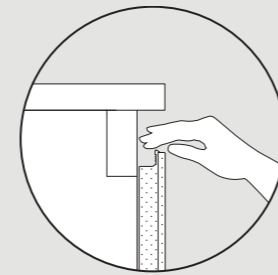

Apertura con gola piatta, telaio Zafferano / Opening with flat groove, Zafferano frame



Basi / Base units

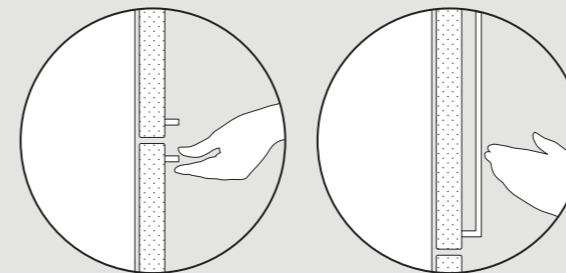

Apertura con maniglia / Opening with handle



Colonne / Tall units

Z/02

IT COMPOSIZIONE COLONNE
CON ISOLA E
TAVOLO INTEGRATO
EN TALL UNIT COMPOSITION
WITH ISLAND AND
BUILT-IN TABLE





Sedia Shift / Shift chair
→ Cat. Complementi Alf DaFrè





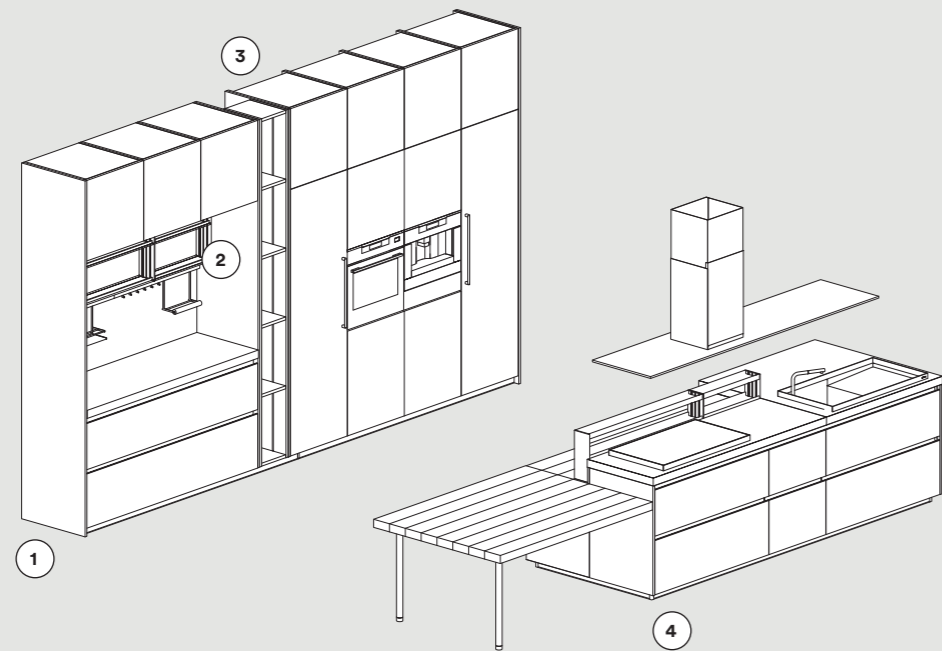

1 COLONNE LOGICA / LOGICA TALL UNITS
 Colonne Logica Laminato Canapa, gola, zoccolo e maniglie Laccato opaco Moka Shine, top e boiserie Laminato Piasentina. / Logica tall units Canapa laminate, groove, plinth and handles Matt Moka Shine lacquer, top and Boiserie Piasentina laminate.

2 MODULI FLAG / FLAG UNITS
 Moduli Flag Moka Stone. / Flag units Moka Stone.

3 VANI A GIORNO / OPEN COMPARTMENTS
 Fashion wood Rovere Carbone. / Carbone oak Fashion Wood.

4 ISOLA / ISLAND
 Isola Laminato Piasentina, vani a giorno Fashion wood Rovere Carbone, gola e zoccolo Laccato opaco Moka Shine, top Laminato Piasentina, piano tavolo Lex Fashion wood Rovere Carbone e gamba D45 verniciato Moka Shine. / Island Piasentina laminate, open compartments Carbone oak Fashion wood, groove and plinth Matt Moka Shine lacquer, top Piasentina laminate, Lex table top Carbone oak Fashion wood and D45 leg painted Moka Shine.

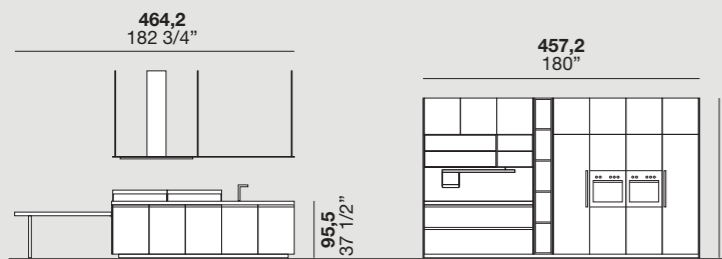

Basi / Base units

Colonne / Tall units

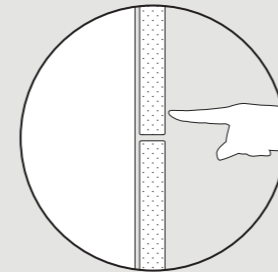

Apertura push-pull / Push-pull opening



Pensili / Tall units

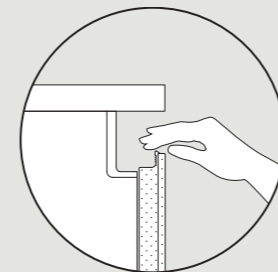

Apertura con gola curva, telaio Zafferano / Opening with curved groove, Zafferano frame



Basi / Base units

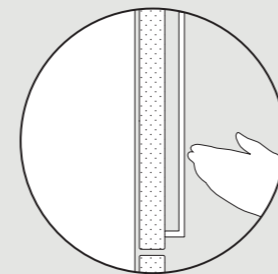

Apertura con maniglia / Opening with handle



Colonne / Tall units

Z/03

**1^{IT} COMPOSIZIONE
COLONNE
CON ISOLA COMPOSTA
EN TALL UNIT
COMPOSITION
WITH COMPOSITE
ISLAND**





Sedia Corium / Corium chair
→ Cat. Complementi Alf DaFrè







Coperture decorative per sponde cassetto-cesto in Laminam Fokos sale / Decorative drawer side covering in Fokos Sale Laminam.

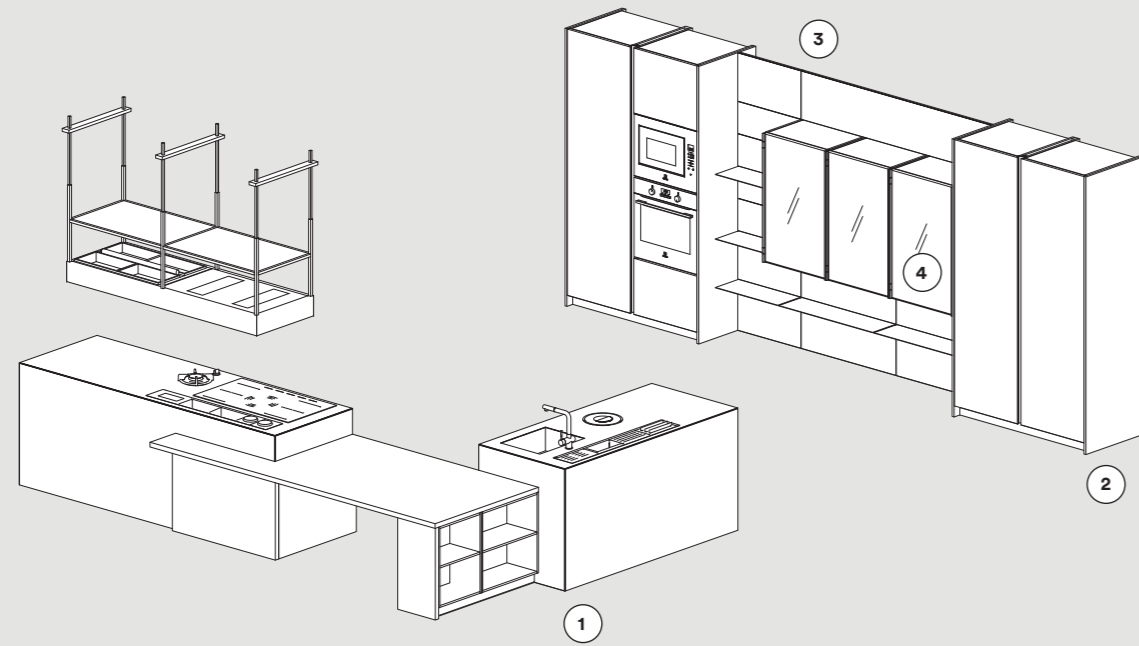

1 ISOLA / ISLAND
Isola Laminam Fokos sale, gola e zoccolo Laccato opaco Moka Shine, top Laminam Fokos sale, vani a giorno e piano tavolo Nobilitato Eukalipto fossile. / Island Fokos Sale Laminam, groove and plinth Matt Moka Shine lacquer, top Fokos Sale Laminam, open compartments and table top Eukalipto Fossile surface.

2 COLONNE LOGICA / LOGICA TALL UNITS
Colonne Logica Nobilitato Eukalipto fossile, gola e zoccolo Laccato opaco Moka Shine. / Logica tall units Eukalipto Fossile surface, groove and plinth Matt Moka Shine lacquer.

3 BOISERIE
Boiserie Laminam Fokos sale, mensole Metallo Moka Shine. / Boiserie Fokos Sale Laminam, shelves Moka Shine metal.

4 PENSILI CANVAS / CANVAS WALL UNITS
Pensili Canvas anta vetro trasparente grigio, telaio Moka Shine, scocca e schiena Nobilitato Eukalipto fossile. / Canvas wall units Grigio transparent glass door, Moka Shine frame, body and back panel Eukalipto Fossile surface.

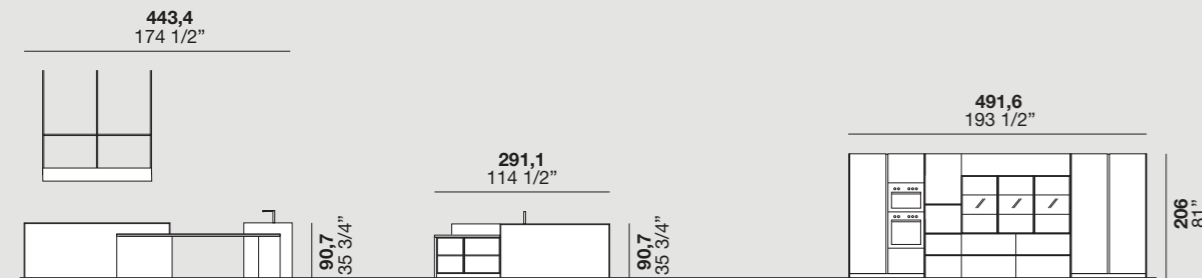

Basi / Base units

Basi / Base units

Colonne / Tall units

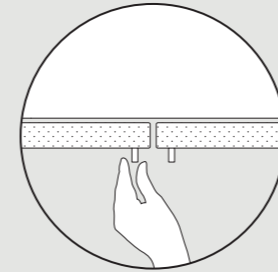

Apertura con maniglia / Opening with handle



Pensili / Tall units

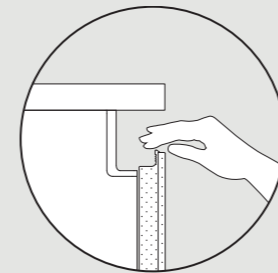

Apertura con gola curva, telaio Zafferano / Opening with curved groove, Zafferano frame



Basi / Base units

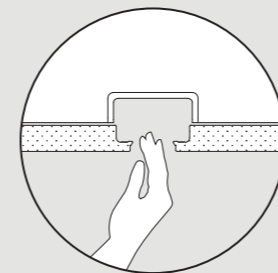

Apertura con gola curva / Opening with curved groove



Colonne / Tall units

Z/04

IT COMPOSIZIONE
AD ANGOLO CON
SNACK INTEGRATO
EN CORNER COMPOSITION
WITH BUILT-IN
BREAKFAST BAR







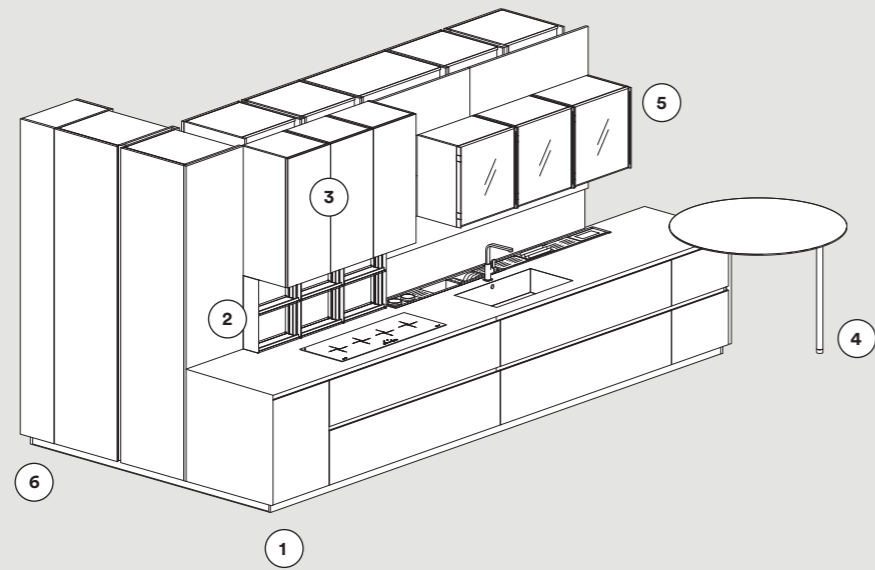

1 BASI / BASE UNITS
Basi Laccato opaco Calce, top Corian Glacier white, gola e zoccolo Laccato opaco Calce. / Base units Matt Calce lacquer, top Glacier White Corian, groove and plinth Matt Calce lacquer.

2 MODULI FLAG / FLAG UNITS
Moduli Flag Moka Stone. / Flag units Moka Stone.

3 PENSILI LOGICA / LOGICA WALL UNITS
Pensili Logica Laccato opaco Calce, boiserie Nobilitato Noce Naturale. / Logica wall units Matt Calce lacquer, boiserie Natural walnut surface.

4 TAVOLO MOON / MOON TABLE
Piano tavolo Moon Noce Naturale e gamba Moka Shine. / Natural Walnut Moon table top and Moka Shine leg.

5 PENSILI CANVAS / CANVAS WALL UNITS
Pensili Canvas anta vetro trasparente grigio, telaio Moka Shine, scocca Laccato opaco Calce, schiena Nobilitato Noce Naturale. / Canvas wall units Grigio transparent glass door, Moka Shine frame, body Matt Calce lacquer, back panel Natural walnut surface.

6 COLONNE LOGICA / LOGICA TALL UNITS
Colonne Logica Laccato opaco Calce e Nobilitato Noce Naturale, gola e zoccolo Laccato opaco Calce e Laccato Moka Shine. / Logica tall units Matt Calce lacquer and Natural walnut surface, groove and plinth Matt Calce lacquer and Moka Shine lacquer.

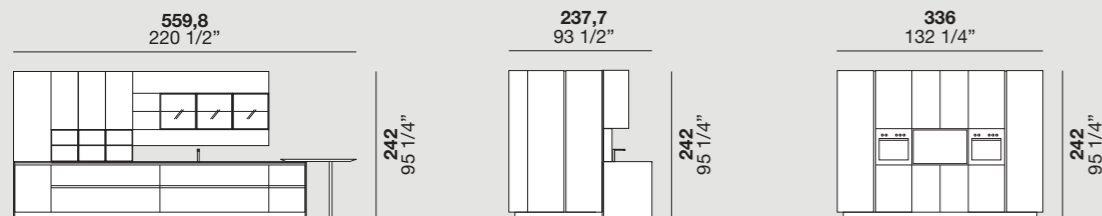

Pensili e basi / Wall units and base units

Colonne / Tall units

Colonne / Tall units

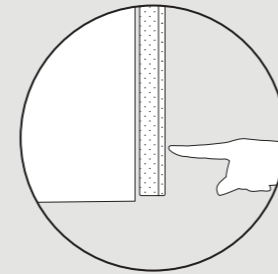

Apertura push-pull / Push-pull opening



Pensili / Tall units

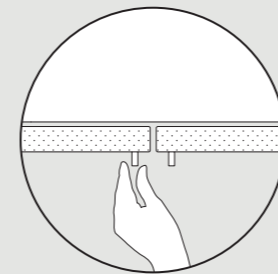

Apertura con maniglia / Opening with handle



Pensili / Tall units

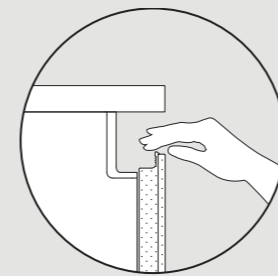

Apertura con gola curva, telaio Zafferano / Opening with curved groove, Zafferano frame



Basi / Base units

Z/05

**1^{IT} COMPOSIZIONE
COLONNE CON
ISOLA COMPOSTA
EN TALL UNIT
COMPOSITION
WITH COMPOSITE
ISLAND**











Coperture decorative per sponde cassetto-cesto in Noce Naturale / Decorative drawer side covering in Natural Walnut.



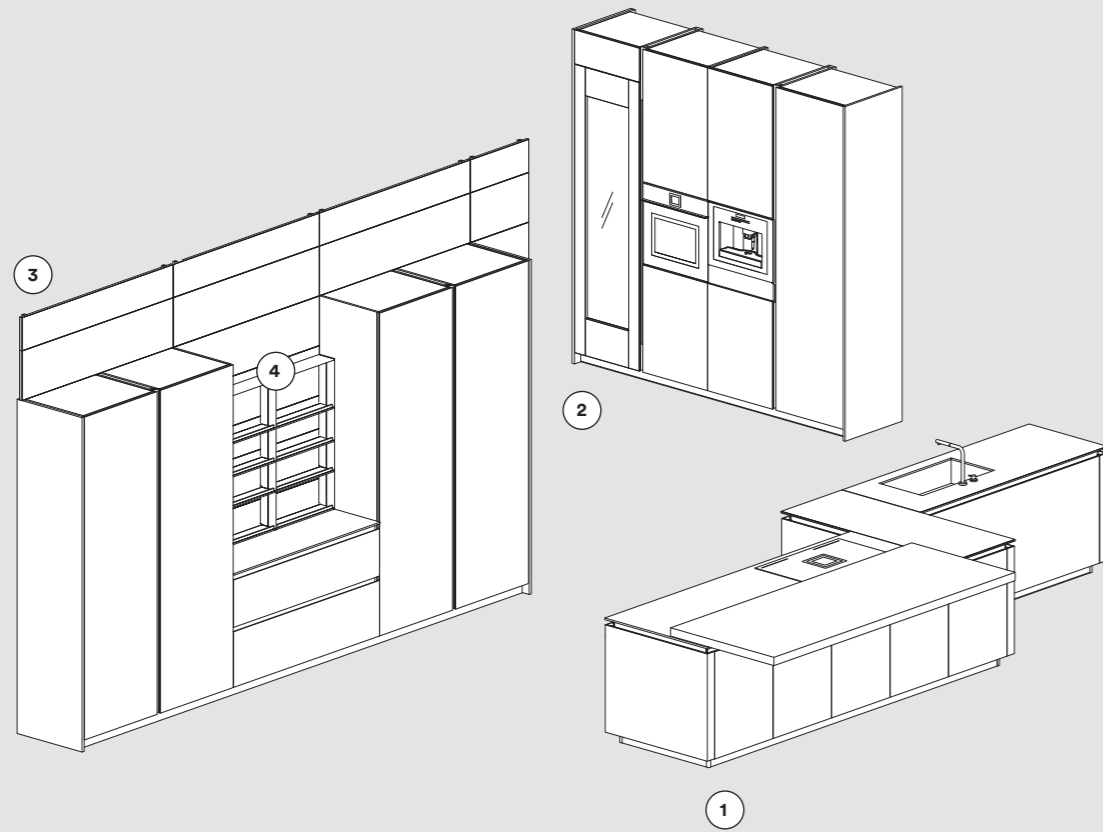

1 ISOLA / ISLAND

Isola Fenix Grigio Efeso, gola e zoccolo
Laccato opaco Moka Shine, piano tavolo
Shift Nobilitato Noce Naturale. / Island
Fenix Grigio Efeso, groove and plinth Matt
Moka Shine lacquer, shift table top Natural
walnut surface.

2 COLONNE / TALL UNITS

Colonne* Fenix Grigio Efeso, gola e zoccolo
Laccato opaco Moka Shine. / Tall units*
Fenix Grigio Efeso, groove and plinth Matt
Moka Shine lacquer.
* Frontale cantinetta **Logica** / **Logica** wine-
rack front.

3 BOISERIE

Boiserie Aludust Peltro. / Boiserie Aludust
Peltro.

4 MODULI FLAG / FLAG UNITS

Moduli Flag Moka Stone. / Flag units Moka
Stone.

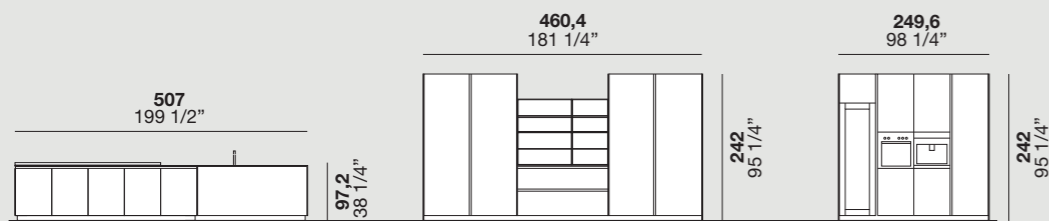

Basi / Base units

Colonne / Tall units

Colonne / Tall units

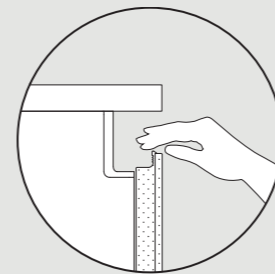

Apertura con gola curva, telaio Zafferano / Opening with curved groove, Zafferano frame



Basi / Base units

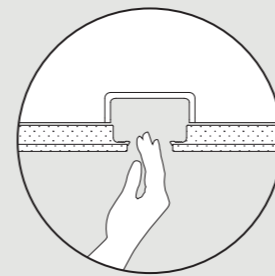

Apertura con gola curva, telaio Zafferano / Opening with curved groove, Zafferano frame



Colonne / Tall units

Z/06

**IT COMPOSIZIONE
COLONNE CON ISOLA
EN TALL UNIT COMPOSITION
WITH ISLAND**









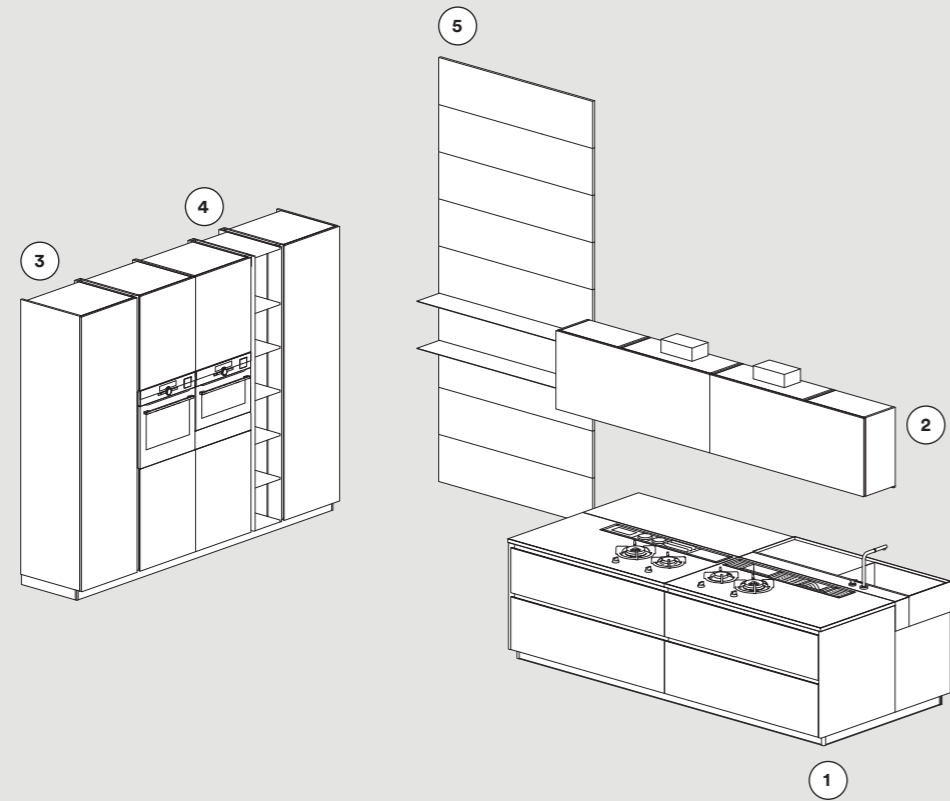

1 ISOLA / ISLAND
Isola Laccato opaco Modica, gola Laccato micalizzato Palladio, zoccolo Laccato Moka Shine, top e modulo Brick Marmo Grafite levigata. / Island Matt Modica lacquer, groove Micalised Palladio lacquer, plinth Moka Shine lacquer, top and Brick unit polished Grafite marble.

2 PENSILI / WALL UNITS
Pensili Laccato opaco Arena. / Wall units Matt Arena lacquer.

3 VANO A GIORNO / OPEN COMPARTMENT
Vano a giorno Laccato opaco Modica. / Open compartment Matt Modica lacquer.

4 COLONNE / TALL UNITS
Colonne Laccato opaco Arena, zoccolo Laccato opaco Arena. / Tall units Matt Arena lacquer, plinth Matt Arena lacquer.

5 BOISERIE
Boiserie Fashion wood Rovere Carbone, mensole Metallo Moka Shine. / Boiserie Carbone oak Fashion Wood, shelves Moka Shine metal.

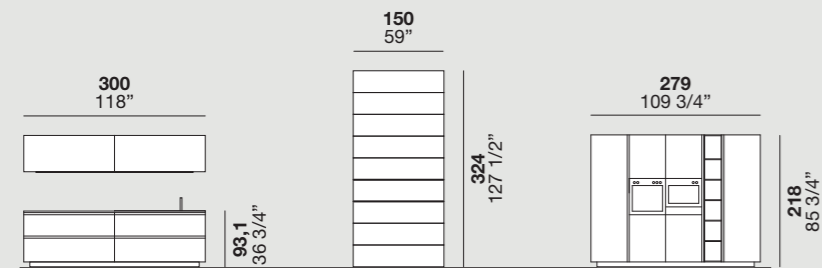

Basi / Base units

Colonne / Tall units



Led interni vano giorno / Open compartment internal LED lighting



Basi / Base units

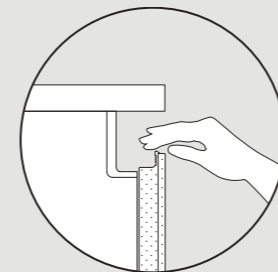

Apertura con gola curva, telaio Zafferano / Opening with curved groove, Zafferano frame



Colonne / Tall units

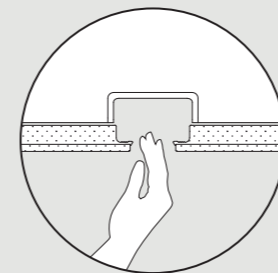

Apertura con gola curva, telaio Zafferano / Opening with curved groove, Zafferano frame

Z/07

**IT COMPOSIZIONE A "U"
EN U-SHAPED
COMPOSITION**







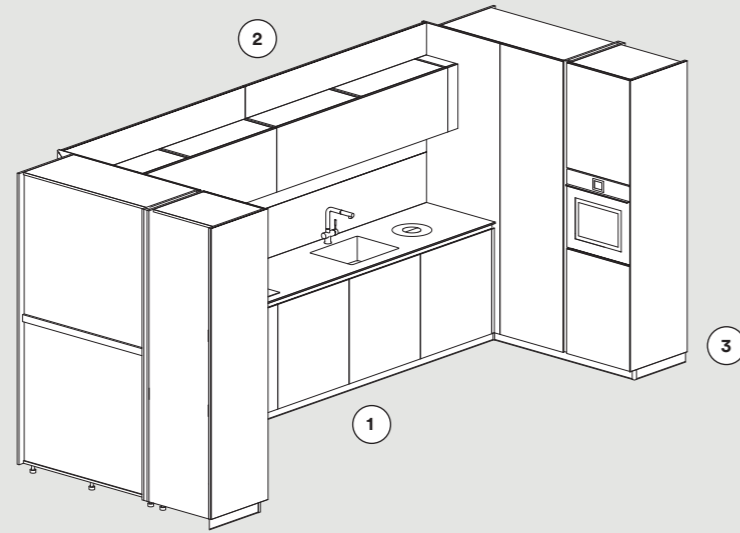

1 BASI E PENSILI / BASE UNITS AND WALL UNITS

Basi e pensili Vetro lucido Greige, gola Laccato opaco Tortora, zoccolo Laccato Moka Shine, top Laminam Pietra di Savoia grigia bocciardata. / Base units and wall units High-gloss Greige glass, groove Matt Tortora lacquer, plinth Moka Shine lacquer, top Bush-hammered Pietra di Savoia Grigio Laminam.

2 BOISERIE

Boiserie Laminam Pietra di Savoia grigia bocciardata. / Boiserie Bush-hammered Pietra di Savoia Grigio Laminam.

3 COLONNE / TALL UNITS

Colonne Vetro lucido Selce, zoccolo Laccato Moka Shine. / Tall units High-gloss Selce glass, Plinth Moka Shine lacquer.

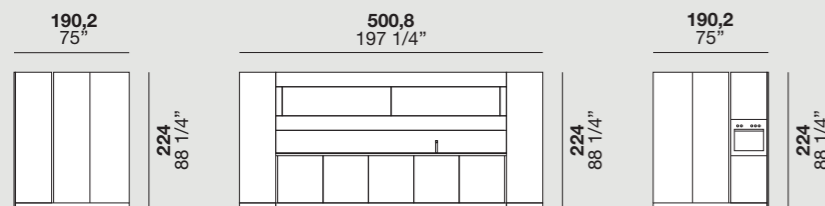

Colonne / Tall units

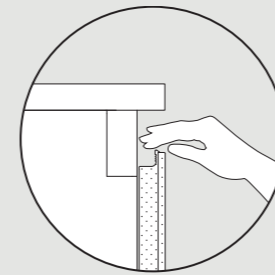

Apertura con gola piatta, telaio Zafferano / Opening with flat groove, Zafferano frame



Basi / Base units

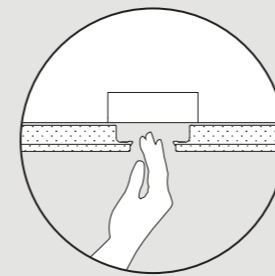

Apertura con gola piatta, telaio Zafferano / Opening with flat groove, Zafferano frame



Colonne / Tall units



**IT ZAFFERANO
E LOGICA L90
UNIONE
PERFETTA
EN ZAFFERANO
AND LOGICA L90
THE PERFECT
JOIN**

ZAFFERANO

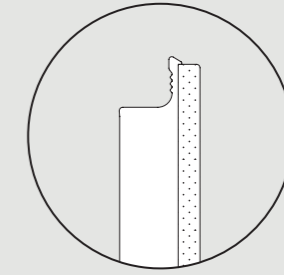

Laccati opachi o lucidi
→ Matt or high-gloss lacquers

Laccati Soft Touch opachi
→ Matt soft-touch lacquers

**Laccati micalizzati
Laccati effetto metallo**
→ Micalised lacquers and metal effect

**Laccati effetto metallo
satinato**
→ Satin metal effect lacquers

**Vetri colorati lucidi
e acidati**
→ Etched and high-gloss coloured glass

**Laminati con bordo
unicolor**
→ Laminates with Unicolor edge

Fenix
→ Fenix

Aludust
→ Aludust

Laminam
→ Laminam

Pietre Luxury
→ Luxury stones

Corian
→ Corian

LOGICA L90

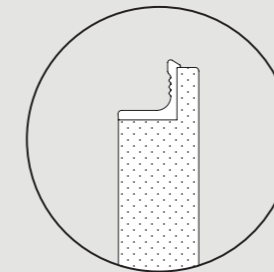

Laccati opachi o lucidi
→ Matt or high-gloss lacquers

Laminati
→ Laminati

Legno
→ Wood

Nobilitato
→ Surfaced

Fenix
→ Fenix

IT SISTEMA BRICK EN BRICK SYSTEM

Valdesign presenta Brick. Il nuovo sistema di piani in appoggio a basi H. 60,8 cm, disponibile nelle seguenti tipologie: Brick vasca, Brick piano cottura, Brick vasca + piano.

Valdesign presents Brick. The new system of tops stacked on base units measuring H. 60.8 cm comes in the following types: Sink Brick, Hob Brick, Sink + Hob Brick.

1 BRICK VASCA + PIANO COTTURA /
SINK + HOB BRICK

2 BRICK NEUTRO / PLAIN BRICK

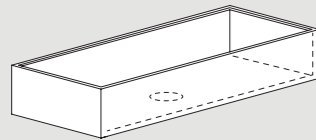
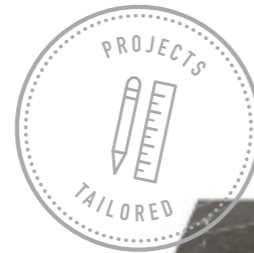

Brick vasca / Sink Brick

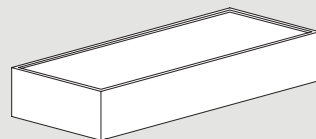

Brick piano cottura / Hob Brick

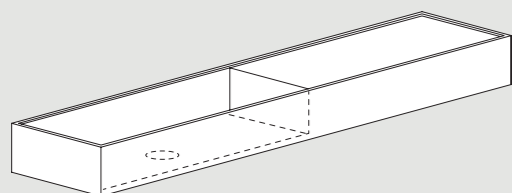

Brick vasca + piano cottura / Sink + Hob Brick

IT ESEMPI DI COMPOSIZIONI BRICK

Gli elementi Brick hanno altezza di 23,3 cm (Laminam) e di 24,3 cm (Marmo, Granito) e vanno posizionati sopra a basi specifiche di altezza 60,8 cm con un cassetto e un cestone. / Brick modules measure H. 23.3 cm (Laminam) and 24.3 cm (Marble, Granite) and are stacked on specific base units measuring 60.8 cm with different depth drawers.

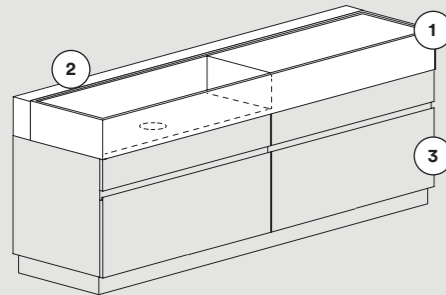

1 / Brick vasca + piano cottura
Sink + Hob Brick

2 / Brick neutro
Plain Brick

3 / Nuova base H 60,8 cm
New base unit H. 60.8 cm

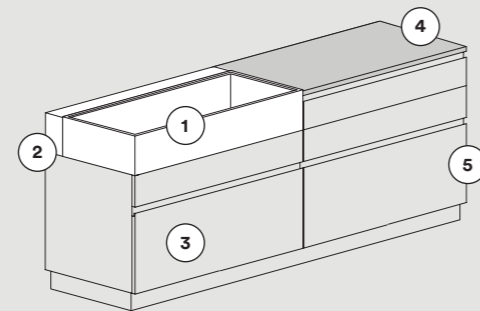

1 / Brick vasca
Sink Brick

2 / Brick neutro
Plain Brick

3 / Nuova base H 60,8 cm
New base unit H. 60.8 cm

4 / Piano Sp. 2 cm
Top 2 cm thick

5 / Base H 81,5 cm
Base unit H 81.5 cm

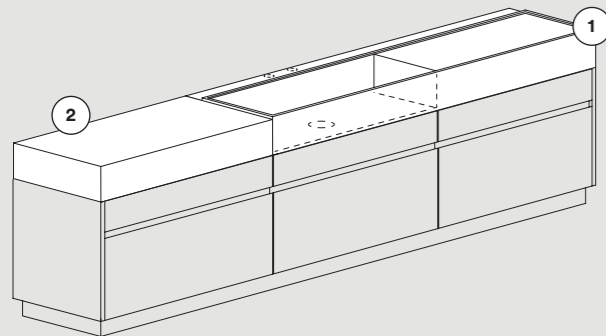

COMPOSIZIONI A MURO
→ Wall composition

1 / Brick vasca + piano cottura
Sink + Hob Brick

2 / Brick neutro
Plain Brick

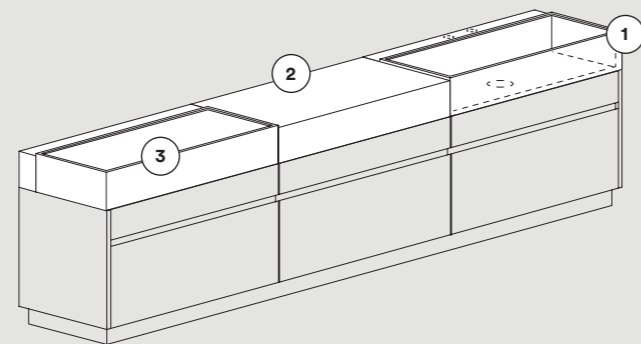

1 / Brick vasca
Sink Brick

2 / Brick neutro
Plain Brick

3 / Brick piano cottura
Hob Brick

EN EXAMPLES OF BRICK COMPOSITIONS

Gli elementi Brick vasca o piano cottura vengono abbinati a Brick "neutri". I Brick neutri fungono da elementi di compensazione in cui possono essere inseriti i fori per miscelatore. Permettono inoltre di creare composizioni isola. / Sink Brick and Hob Brick modules are paired with plain Brick modules. Plain Brick modules act as compensation and can be drilled with a holes for a mixer tap. They can also be used to create an island composition.

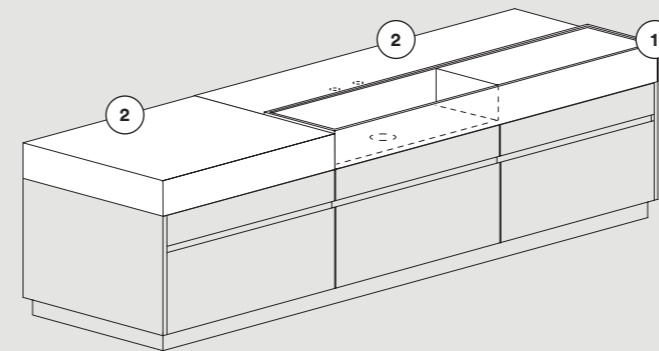

COMPOSIZIONI ISOLA
→ Island compositions

1 / Brick vasca + piano cottura
Sink + Hob Brick

2 / Brick neutro
Plain Brick

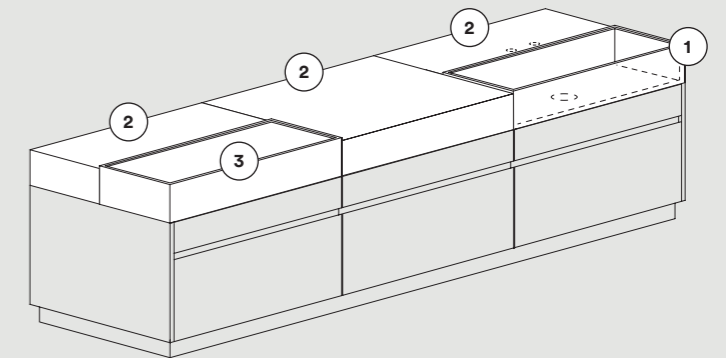

1 / Brick vasca
Sink Brick

2 / Brick neutro
Plain Brick

3 / Brick piano cottura
Hob Brick

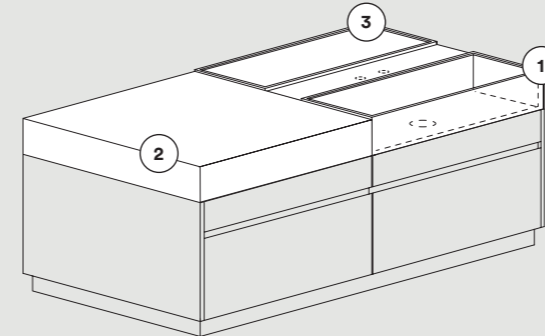

1 / Brick vasca
Sink Brick

2 / Brick neutro
Plain Brick

3 / Brick piano cottura
Hob Brick

IT VALDESIGN È DA SEMPRE ATTENTA ALLA RIDUZIONE DEGLI SPRECHI, AL RICICLO E ALLA REALIZZAZIONE DI PRODOTTI DUREVOLI. UNA LUNGA DURATA EQUIVALE A MENO RIFIUTI E A UN UTILIZZO PIÙ EFFICIENTE DELLE RISORSE. EN VALDESIGN HAS ALWAYS CARED ABOUT REDUCING WASTE, RECYCLING AND BUILDING LONG-LASTING PRODUCTS. LONG-LASTING PRODUCTS MEAN LESS WASTE AND MORE RESOURCE EFFICIENCY.



- 1 ALLUMINIO / ALUMINIUM
- 2 VETRO / GLASS
- 3 LAMINAM
- 4 CORIAN
- 5 FENIX

IT LA QUALITÀ DEI NOSTRI PRODOTTI È FRUTTO DI UN LAVORO ATTENTO IN TUTTE LE FASI: DALLA PROGETTAZIONE, ALLA PRODUZIONE E ALLA SELEZIONE DI TUTTI GLI ELEMENTI CHE COMPONGONO LE NOSTRE CUCINE. EN THE QUALITY OF OUR PRODUCTS IS THE RESULT OF CAREFUL WORK AT ALL STAGES OF THE PROCESS, FROM THE DESIGN STAGE TO PRODUCTION, INCLUDING ALL ELEMENTS THAT MAKE UP OUR KITCHENS.

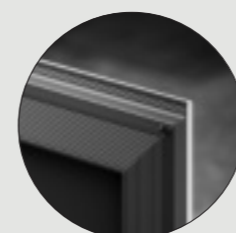

TELAIO ANTA / DOOR FRAME
 Il telaio in alluminio garantisce resistenza, idrorepellenza, indeformabilità all'imbarcamento e assenza di ossidazione. / The aluminium frame is resistant and water-repellent, and it won't bow, deform or tarnish.

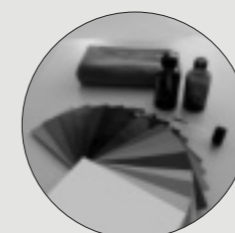

LACCATURA / LACQUERING
 Il nostro processo di laccatura prevede la spazzolatura nel caso della finitura lucida in tutte le superfici a vista. / Our lacquering process includes brushing to achieve the high-gloss finish for all visible surfaces.



GUIDE / RUNNERS
 I nostri cassetti sono forniti di guide in acciaio con portata collaudata di 40 kg alla coppia per profondità fino a 50 cm e 70 kg alla coppia per profondità 60 cm e movimenti garantiti per 80.000 cicli di apertura e chiusura. / Drawers are supplied with steel runners, which are tested to support a load of 40 kg per pair for depths up to 50 cm, and 70 kg per pair for depths of 60 cm. Movement guaranteed for 80,000 opening and closing cycles.



FERRAMENTA / HARDWARE
 Ogni mobile è fornito di ferramenta per garantire l'affidabilità nel tempo quali cerniere ad innesto rapido con ammortizzatore di chiusura per le ante e guide con chiusura assistita per cassetti e cestoni. / Each unit comes with fixtures and fittings to ensure long-lasting reliability. These include snap-in hinges with assisted closing for the doors and soft-close runners for the drawers.



SCOCHE / BODIES
 Le nostre scocche sono idrorepellenti IDROLEB. / The unit bodies are water-repellent (IDROLEB).



SCOCHE / BODIES
 Le nostre scocche sono a bassa emissione di formaldeide secondo normative EPA e CARB. / Our unit bodies have low formaldehyde emissions according to the EPA and CARB regulations.

art direction
Brunella Vaccher
Genny Canton

set coordinator/graphic
Genny Canton Studio

digital image
Nudesign

separations
Lucegroup

print
Sincromia

stampato
12 /2022



Valdesign®

cucine

VALDESIGN srl
Via per Sacile 75
31018 Francenigo di Gaiarine
Treviso, Italy
Tel. +39 0434 769811
Fax +39 0434 769845
www.valdesigncucine.it
info@valdesigncucine.it

Verifica le finiture disponibili sul nostro sito internet. / Check the finishes available on our website. / Consulte los acabados disponibles en nuestro sitio web. / Vérifiez les finitions disponibles sur notre site internet. / Überprüfen Sie auf unserer Webseite, ob die gewünschte Ausführung erhältlich ist. / Познакомьтесь с вариантами отделки на нашем интернет-сайте www.valdesigncucine.it

ALF UNO s.p.a. si riserva di apportare in qualsiasi momento modifiche a prodotti, misure e materiali, che ritenesse utili per esigenze di carattere produttivo e commerciale. Per essere sempre aggiornati vi invitiamo a consultare il nostro sito internet www.valdesigncucine.it

LE FINITURE

I materiali utilizzati dalla nostra azienda sono selezionati tra i più affidabili per applicazione e resa estetica. Nonostante questo devono considerarsi tollerabili alcune differenze dovute alle caratteristiche stesse di materiali come essenze naturali, vetri, laccature e all'artigianalità di alcune fasi del processo produttivo che da sempre è un nostro valore aggiunto. Inoltre alcune finiture possono subire nel tempo maturazioni dovute all'azione della luce e del tempo. È importante quindi specificare se nell'ordine vi sono sostituzioni o completamenti per valutare insieme il miglior modo di procedere. Le tonalità di colore e le finiture illustrate vanno considerate puramente indicative. Verificare sempre la fattibilità dell'abbinamento finiture consultando l'interno del listino.

ALF UNO s.p.a. reserves the right to make any changes to products, measurements and materials at any time deemed useful for manufacturing and sales purposes. To stay up to date at all times, please visit our website www.valdesigncucine.it

FINISHES

The materials we use are selected among the most reliable products in terms of application and aesthetic rendering. Despite this, certain differences due to the very characteristics of materials such as natural wood finishes, glass and lacquers must be considered tolerable, as well as the hand-crafted nature of certain phases of the production process, which has always been one of our added values. In addition, some finishes may change over time, due to the effects of light and time. It is therefore important to specify whether there are replacements or completions in the order to assess the best way to proceed together. The finishes featured in this sample collection are purely indicative and are not available for all products. Please check in the price list if the finish is available for the chosen item. Orders will not be accepted for products with finishes not included in the price list. The colour shades and finishes illustrated herein are to be considered purely indicative. Always check the feasibility of finish combinations by consulting the price list contents.

Logica



Valdesign[®]
cucine

**Indice composizioni
strutturato per
configurazione
ergonomica**

**/
Structured index
of compositions
for an ergonomic
setup**

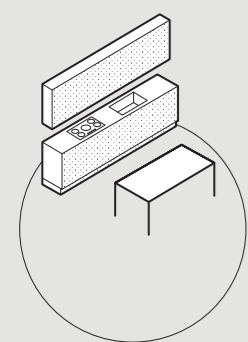

**COMPOSIZIONE LINEARE
CON TAVOLO**
→ linear composition
with table

L / 04 → pag. 30
L / 06 → pag. 48
L / 17 → pag. 148

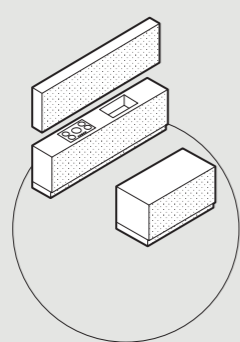

**COMPOSIZIONE LINEARE
CON ISOLA**
→ linear composition
with island

L / 01 → pag. 04
L / 05 → pag. 44
L / 10 → pag. 82
L / 13 → pag. 116
L / 14 → pag. 124
L / 21 → pag. 180

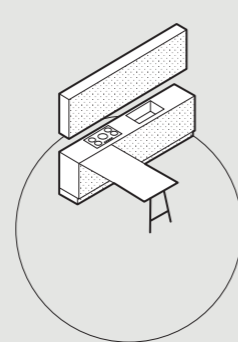

**COMPOSIZIONE LINEARE
CON PIANO SNACK**
→ linear composition with
breakfast bar

L / 15 → pag. 136
L / 20 → pag. 166

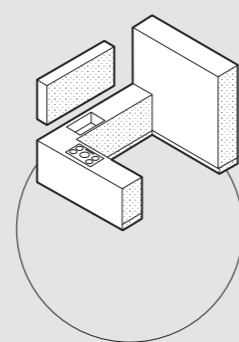

COMPOSIZIONE A "U"
→ U-shaped composition

L / 02 → pag. 12
L / 12 → pag. 100
L / 19 → pag. 162

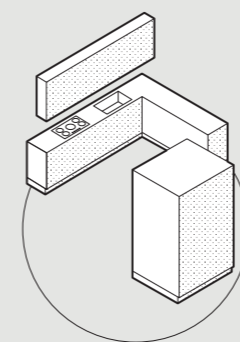

**COMPOSIZIONE A "L"
CON COLONNE**
→ L-shaped composition
with tall units

L / 22 → pag. 182

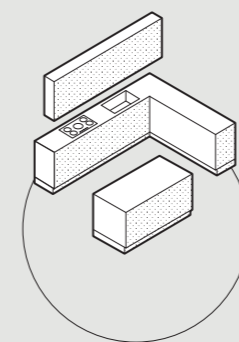

**COMPOSIZIONE A "L"
CON ISOLA**
→ L-shaped composition
with island

L / 07 → pag. 60

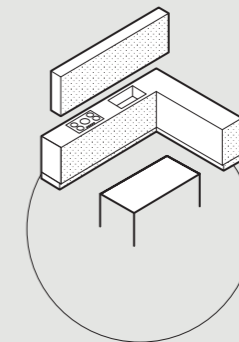

**COMPOSIZIONE A "L"
CON TAVOLO**
→ L-shaped composition
with table

L / 08 → pag. 66
L / 09 → pag. 76
L / 11 → pag. 92
L / 16 → pag. 138
L / 18 → pag. 152

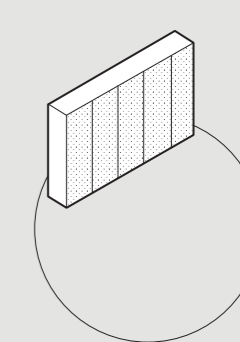

**COMPOSIZIONE CUCINA
A SCOMPARSA**
→ concealed kitchen
composition

L / 03 → pag. 26

comp. L / 01



finiture / finishes
Laminam Fokos sale
Nobilitato Noce naturale / Surfaced natural Walnut
Nobilitato Metal bronze / Surfaced Metal bronze







comp. L / 01

→ **IT**
Basi nobilitato Noce naturale
Gola, profilo "L90" e zoccolo
 Moka shine
Top Laminam Fokos sale

Pensili nobilitato Metal bronze

Colonne con ante rientranti
 nobilitato Metal bronze
Interno Antracite
Maniglia P42 e zoccolo Moka
 shine

→ **EN**
 Surfaced natural Walnut **base**
units
 Moka shine **groove, "L90"**
profile and plinth
 Laminam Fokos sale **top**

Surfaced Metal bronze **wall units**

Surfaced Metal bronze **wall**
units with indented doors
 Antracite body
 Moka shine **P42 handle and**
plinth

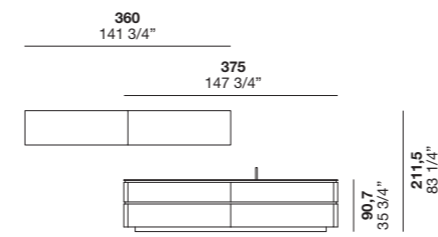

pensili / basi
 wall units / base units

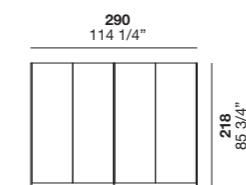

colonne
 tall units

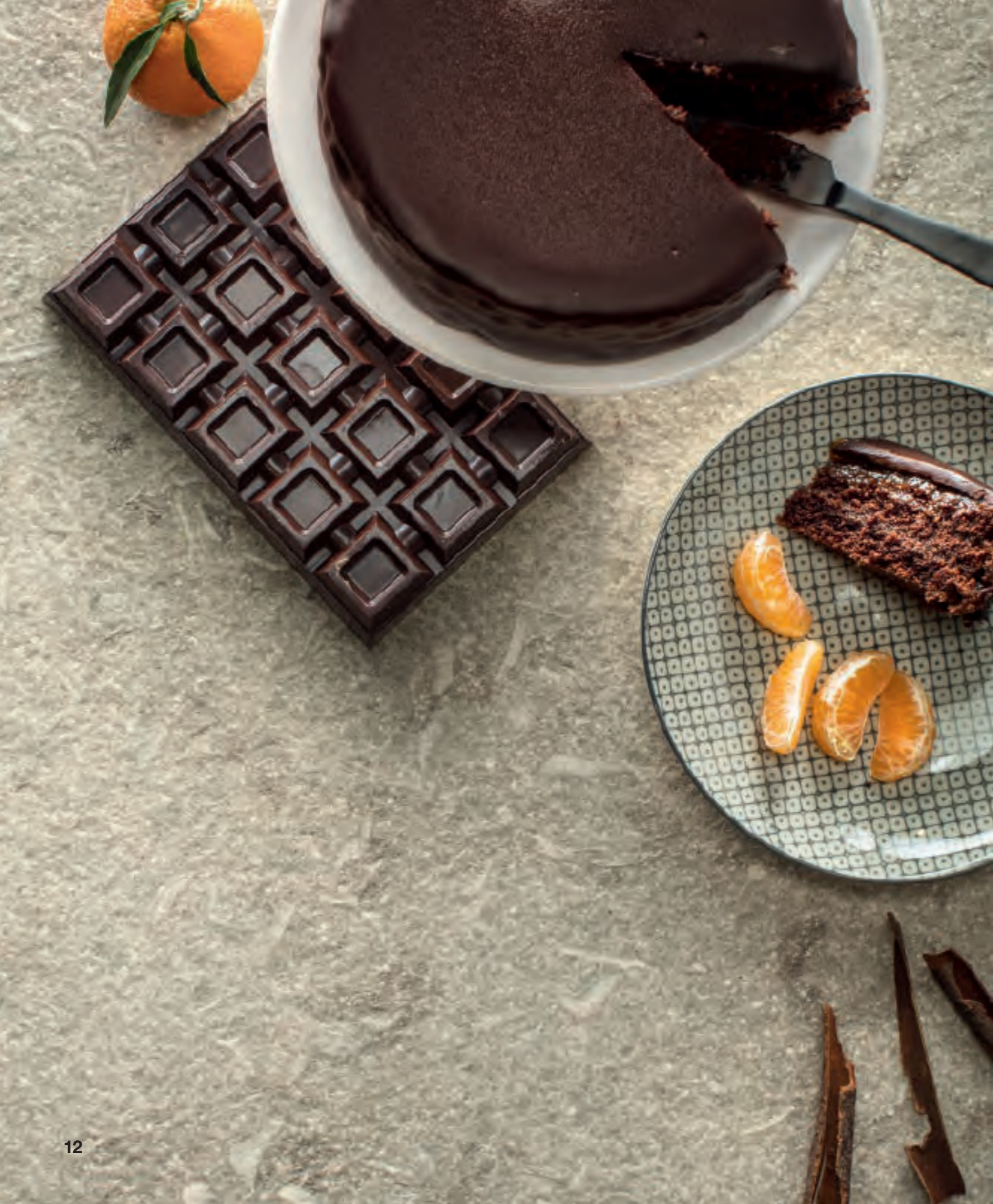

comp. L / 02

finitura / finish
Pietra olivo fiammata spazzolata











comp. L / 02

→ IT
Basi laccato opaco Fango /
 laccato effetto metallo
 satinato Prosecco
Gola, profilo "L90" e **zoccolo**
 Moka shine
Top Pietra olivo
Piano tavolo Olmo antico

Colonne laccato lucido Arena
Maniglia T19/Push-pull e
zoccolo Moka shine

Colonne Canvas anta vetro
 trasparente grigio,
telaio Moka shine
Scocca antracite
Zoccolo Moka shine

→ EN
Matt lacquered Fango base
units / satin metal-effect
 lacquer Prosecco
 Moka shine **groove, "L90"**
profile and plinth
 Olivo stone **top**
 Aged-look elm **table top**

High gloss lacquered Arena
tall units
 Moka shine T19 **handle**/Push-
 pull opening
 Moka shine **plinth**

Canvas tall units with
 transparent grey glass doors,
 Moka shine **frame**
 Antracite **body**
 Moka shine **plinth**

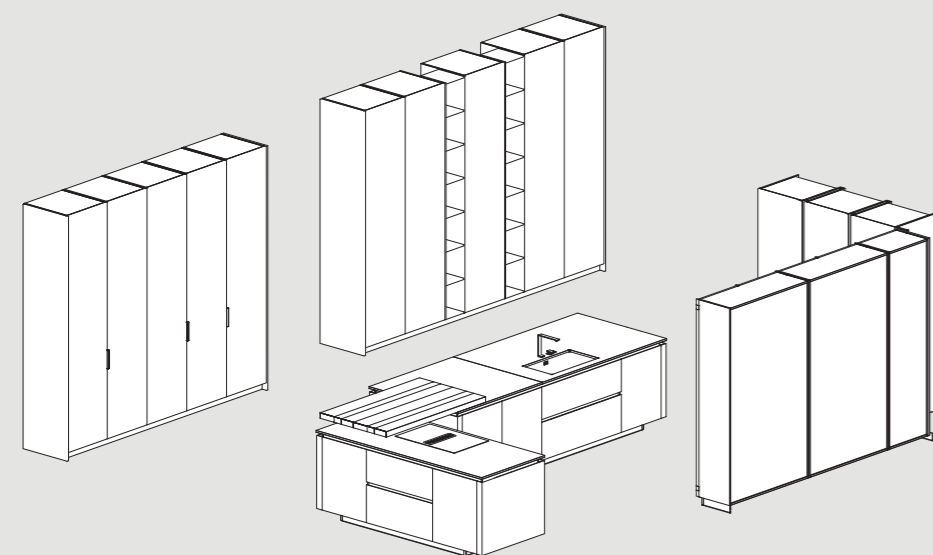

Logica 02



basi
base units

colonne
tall units

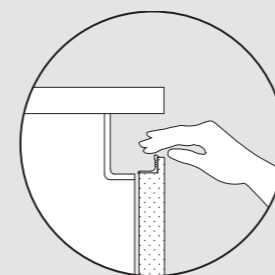

apertura con gola curva / profilo L90
opening with curved groove and L90 profile

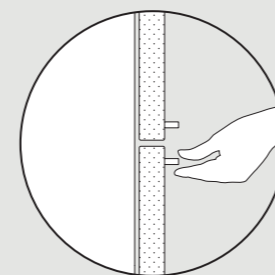

apertura con maniglia
opening with handle

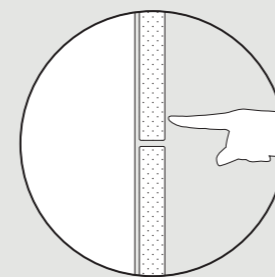

apertura push-pull
push-pull opening



basi
base units



colonne
tall units

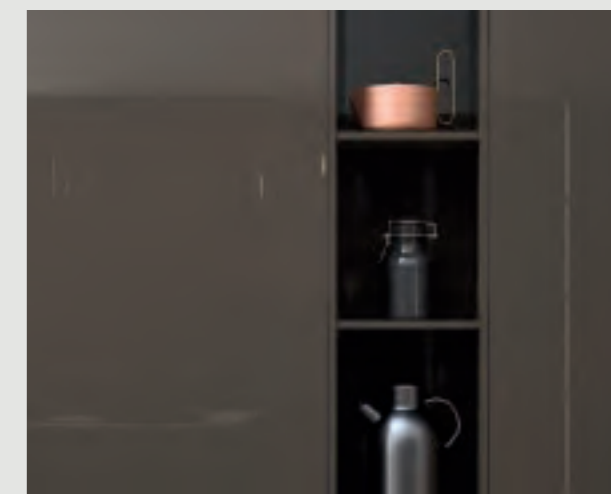

colonne
tall units

comp. L / 03

→ **IT**
Colonne con ante rientranti
laccato opaco Platino
Interno Antracite
Piano Acciaio
Maniglia MZ e **zoccolo** Moka
shine

Tavolo **FUSELLO** e sedia **SHIFT**
(per questi articoli vedi
COMPLEMENTI / Il senso dei
dettagli)

→ **EN**
Matt lacquered Platino **wall**
units with Indented doors
Antracite body
Steel **top**
Moka shine MZ **handle** and
plinth

FUSELLO table and
SHIFT chair (Please see
COMPLEMENTS /
A sense of detail for this items)

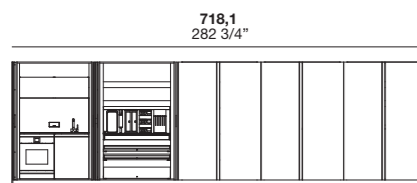

colonne
tall units

comp. L / 03

→ **IT**
Colonne con ante rientranti
laccato opaco Platino
Interno Antracite
Piano Corian Glacier white
Maniglia MZ e **zoccolo** Moka
shine

→ **EN**
Matt lacquered Platino **wall**
units with Indented **doors**
Antracite **body**
Corian Glacier white **top**
Moka shine MZ **handle** and
plinth

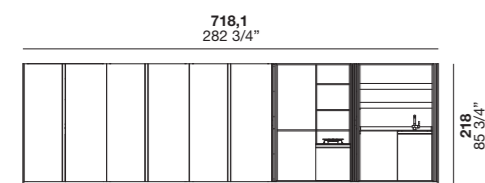

colonne
tall units













comp. L / 04

→ IT

Basi laccato opaco Fango
Gola e profilo "L90" laccato opaco Fango
Zoccolo laccato opaco Fango
Top K-Proof Gaja Venus Sandlite

Pensili laccato effetto metallo
 Rame brunito

Colonne laccato effetto metallo
 Rame brunito

Libreria **MY SPACE** laccato opaco Fango
 (per questo articolo vedi MY SPACE / Spazio alle emozioni)

Composizione giorno **DAY COLLECTION**
 (per questo articolo vedi DAY COLLECTION / Un giorno speciale)

Tavolo **LE20** e sedia **VIKY 2**
 (per questi articoli vedi COMPLEMENTI / Il senso dei dettagli)

→ EN

Matt lacquered Fango base units
Groove and "L90" profile in matt lacquered Fango
Matt lacquered Fango plinth
 K-Proof Gaja Venus Sandlite **top**

Rame Brunito metal-effect lacquered **wall units**

Rame Brunito metal-effect lacquered **tall units**

MY SPACE bookcase in matt lacquered Fango
 (Please see MY SPACE / Space to emotions for this item)

DAY COLLECTION living room composition
 (Please see DAY COLLECTION / A special day for this item)

LE20 table and **VIKY 2** chair
 (Please see COMPLEMENTS / A sense of detail for these items)

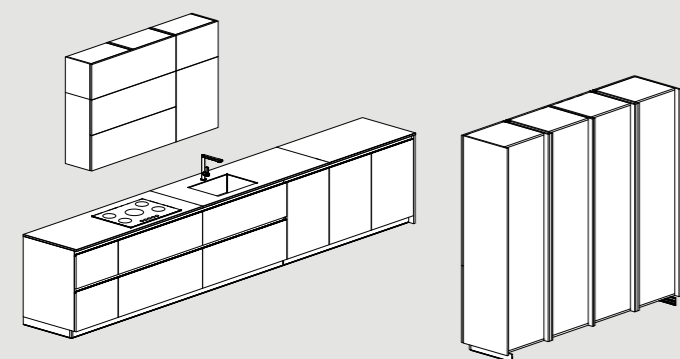

Logica 04

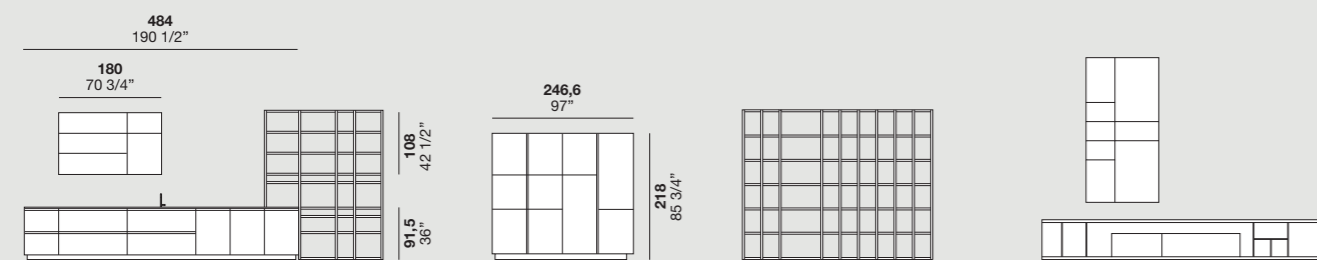

pensili / basi wall units / Base units **libreria MySpace** MySpace bookcase **colonne** tall units **libreria MySpace** MySpace bookcase **composizione Day collection** Day collection composition

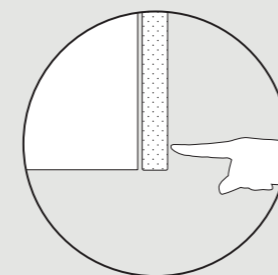

push pull
push-pull opening

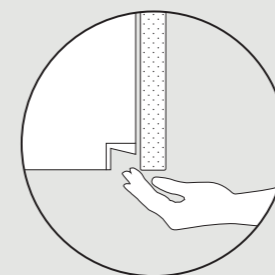

profilo gola
opening with groove profile

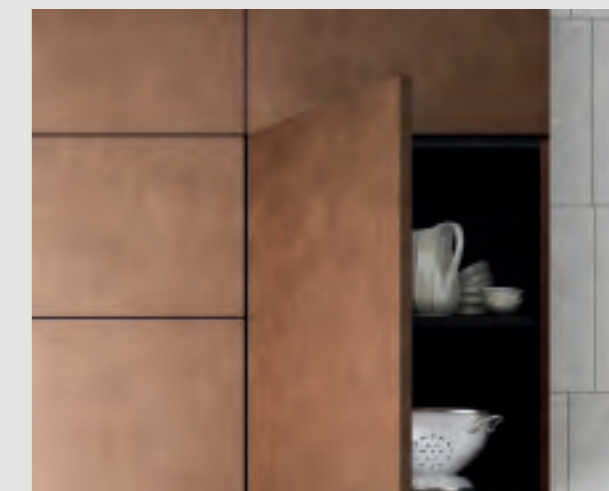

pensili
wall units

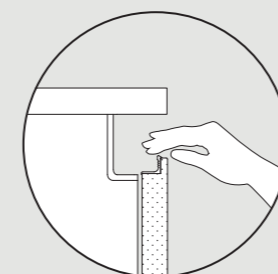

apertura con gola curva / profilo L90
opening with curved groove and L90 profile



basi
base units

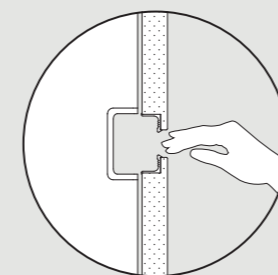

gola curva / profilo L90
Opening with curved groove and L90 profile



colonne
tall units

comp. L / 05



finiture / finishes
Fashion wood rovere Fossile / Fashion wood Fossile oak
Dekton Natural Kelya



comp. L / 05

→ **IT**
Basi Fashion wood rovere
 Fossile
Gola e zoccolo Moka shine
Piano Dekton Natural Kelya
Piano snack Fashion wood
 rovere Naturale

Colonne laccato effetto metallo
 Rame brunito
Gola e zoccolo Moka shine

→ **EN**
 Fashion wood Fossile oak **base
 units**
 Moka shine **groove and plinth**
 Dekton Natural Kelya **top**
 Fashion wood Fossile oak
snack table

Metal effect Rame brunito
 lacquered **wall units**
 Moka shine **groove and plinth**

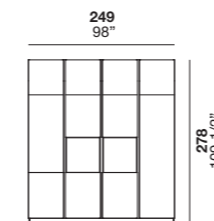

colonne
tall units

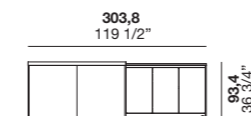

basi
base units











comp. L / 06

→ IT

Basi Nobilitato Old Copper
Gola e profilo "L40" laccato opaco Moka Shine
Zoccolo laccato opaco Moka Shine
Top Cemento Grigio

Pensili Cemento Grigio

Elementi "Basic" Nobilitato Old Copper

Colonne Nobilitato Old Copper / laccato opaco Platino
 Inserimento a giorno con mensoline laccato opaco Platino

Armadio **POKER** laccato opaco Platino
 (per questo articolo vedi POKER / Il luogo perfetto)

Libreria **MY SPACE**
 (per questo articolo vedi MY SPACE / Spazio alle emozioni)

→ EN

Surfaced Old Copper **base units**
 Matt lacquered Moka Shine **groove** and **"L40" profile**
 Matt lacquered Moka Shine **plinth**
 Grigio cement **top**

Grigio cement **wall units**

Surfaced Old Copper **"Basic" units**

Surfaced Old Copper / matt lacquered Platino **tall units**
 Open element with small matt lacquered Platino shelves

Matt lacquered Platino **POKER** wardrobe
 (Please see POKER / The perfect place for this item)

MY SPACE bookcase
 (Please see MY SPACE / Space to emotions for this item)

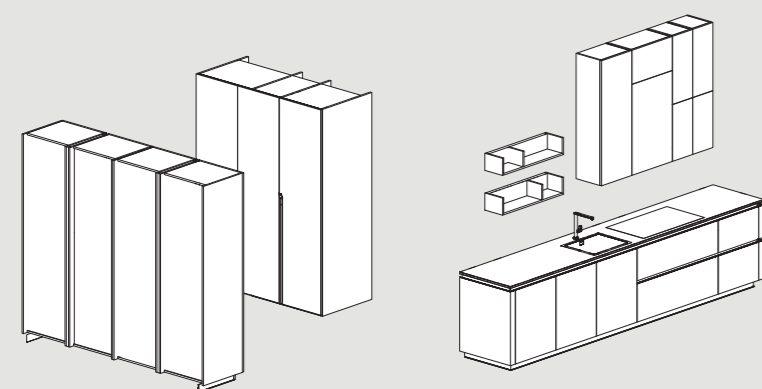

Logica 06

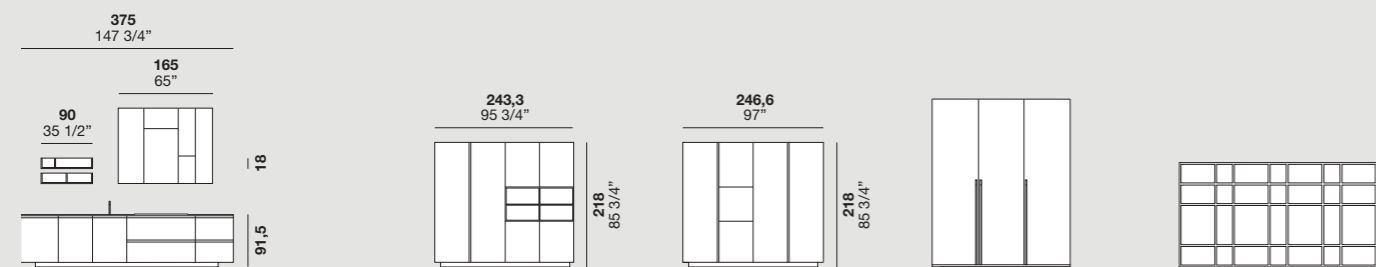

elementi Basic / pensili / basi
 "Basic" units / wall units / base units

colonne
 tall units

colonne
 tall units

Poker armadi
 Poker wardrobes

My Space composizione
 My Space composition

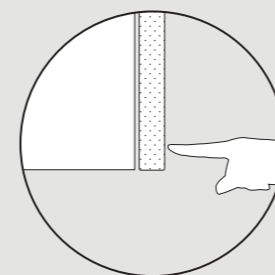

push pull
 push-pull opening

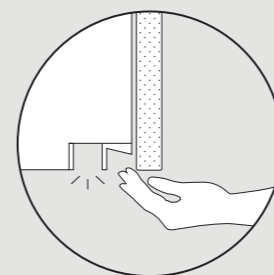

profilo gola / led
 Opening with LED groove profile



pensili
 wall units

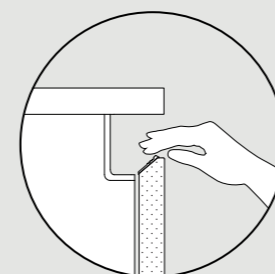

apertura con gola curva / profilo L40
 opening with curved groove and L40 profile



basi
 base units

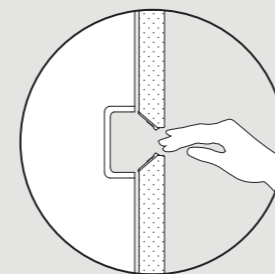

gola curva / profilo L90
 opening with curved groove and L90 profile



colonne
 tall units

comp. L / 07

finiture / finishes
Marmo Grafite levigata / Grafite levigata marble
Fashion wood rovere Ghiro / Fashion wood Ghiro oak
Vetro trasparente grigio / Transparent grey glass





comp. **L / 07**

→ **IT**

Basi laccato Arena opaco
Gola e zoccolo Moka shine
Top Marmo Grafite levigata
Piano snack Fashion wood rovere Ghira
Ghiro
Telaio Titan Moka shine

Colonne / pensili Canvas anta
 vetro trasparente grigio,
Telaio Moka shine
Schiene Fashion wood rovere Ghira

Colonne laccato Arena opaco /
 Fashion wood rovere Ghira
Gola e zoccolo Moka shine

Sedia **CORIUM**
 (per questi articoli vedi
 COMPLEMENTI / Il senso dei
 dettagli)

→ **EN**

Matt lacquered Arena **base units**
 Moka shine **groove** and **plinth**
 Grafite levigata marble **top**
 Fashion wood Ghira oak **snack**
table
 Moka shine **Titan frame**

Canvas tall units / Wall units with
 Transparent grey glass doors,
 Moka shine **frame**,
 Fashion wood Ghira oak **back**
panels

Matt lacquered Arena / Fashion
 wood Ghira oak **wall units**
 Moka shine **groove** and **plinth**

CORIUM chair
 (Please see COMPLEMENTS / A
 sense of detail for this items)

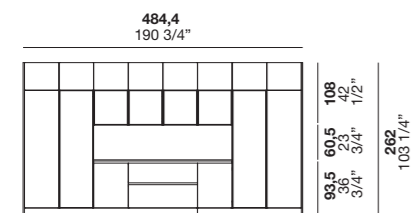

pensili / basi
 wall units / base units

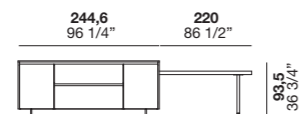

basi
 base units

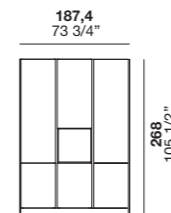

colonne
 tall units











comp. L / 08

→ IT
Basi laccato lucido Fango
Gola, profilo "L40" e **zoccolo**
 Moka shine
Top Dekton Natural kira

Pensili Canvas anta vetro
 trasparente grigio,
telaio Moka shine
Schiene Fashion wood rovere
 Ghiro

Colonne laccato opaco Fango
Gola, profilo "L90"/"L40" e
zoccolo Moka shine

Tavolo **LE20** e sedia **SHIFT**
 (per questi articoli vedi
 COMPLEMENTI / Il senso dei
 dettagli)

→ EN
 High gloss lacquered Fango
base units
 Moka shine **groove, "L40"**
profile and plinth
 Dekton Natural kira **top**

Canvas wall units with
 transparent grey glass doors,
 Moka shine **frame**
 Fashion wood Ghiro oak **back**
panels

Matt lacquered Fango **tall units**
 Moka shine **groove,**
"L90"/"L40" profile and **plinth**

LE20 table and **SHIFT** chair
 (Please see COMPLEMENTS / A
 sense of detail for these items)

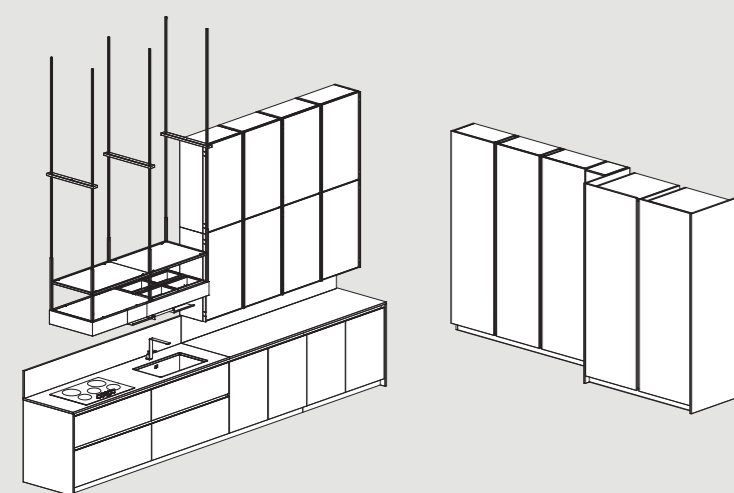

Logica 08

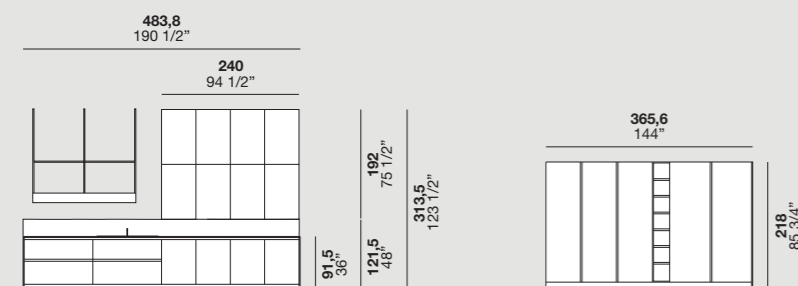

pensili / basi
 wall units / base units

colonne
 tall units

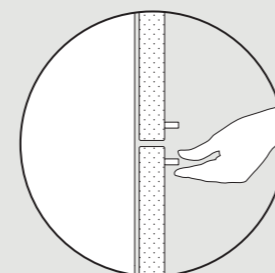

apertura con maniglia
 opening with handle



pensili
 wall units

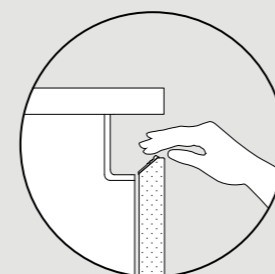

apertura con gola curva / profilo L40
 opening with curved groove and L40 profile



basi
 base units

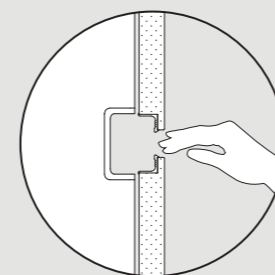

gola curva / profilo L90
 opening with curved groove and L90 profile



colonne
 tall units



comp. L / 09

comp. L / 09

LOGICA

finiture / finishes
Nobilitato Eukalipto fossile / Surfaced Eukalipto fossile
Laminam Piasentina grigio fiammato
Vetro trasparente grigio / Transparent grey glass

comp. L / 09



comp. L / 09



comp. L / 09

→ **IT**
Basi nobilitato Eukalipto fossile
Gola, profilo "L40" e zoccolo
 Moka shine
Top / Schienale Laminam
 Piasentina grigio fiammato

Pensili laccato opaco Aghata

Vani a giorno nobilitato
 Eukalipto fossile

Colonne nobilitato Eukalipto
 fossile
Maniglione e zoccolo Moka
 shine

Colonne Canvas anta vetro
 trasparente grigio,
telaio Moka shine
Schiene laccato opaco Aghata
Fianchi nobilitato Eukalipto
 fossile
Scocca antracite
Zoccolo Moka shine

Tavolo **FYRA** e sedia **RAKU**
 (per questi articoli vedi
 COMPLEMENTI / Il senso dei
 dettagli)

→ **EN**
 Surfaced Eukalipto fossile **base**
units
 Moka shine **groove, "L40"**
profile and plinth
 Laminam Piasentina grigio
 fiammato **top / back panel**

Matt lacquered Aghata **wall**
units

Surfaced Eukalipto fossile **open**
units

Surfaced Eukalipto fossile **wall**
units
 Moka shine **Maniglione and**
plinth

Canvas **tall units** with
 transparent grey glass **doors**,
 Moka shine **frame**
 Matt lacquered Aghata **back**
panel
 Surfaced Eukalipto fossile **side**
panels
 Antracite **body**
 Moka shine **plinth**

FYRA table and **RAKU** chair
 (Please see COMPLEMENTS / A
 sense of detail for these items)

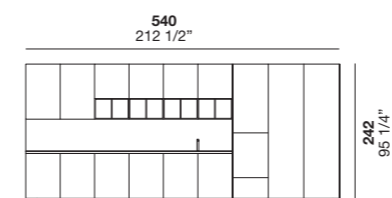

pensili / basi / colonne
 wall units / base units / tall units

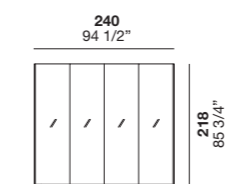

colonne
 tall units

comp. L / 10

finitura / finish
Acciaio / Steel









comp. L / 10

→ IT

Basi Rovere antico Ghiro
Gola laccato opaco Piombo
Zoccolo laccato opaco Piombo
Top Acciaio
Colonne laccato opaco Piombo

→ EN

Ghiro aged-look oak **base units**
 Matt Piombo lacquered **groove**
 Matt Piombo lacquered **plinth**
 Steel **top**
 Matt Piombo lacquered **tall units**

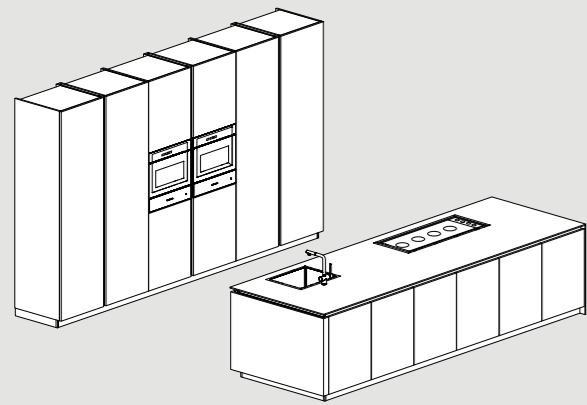

Logica 10

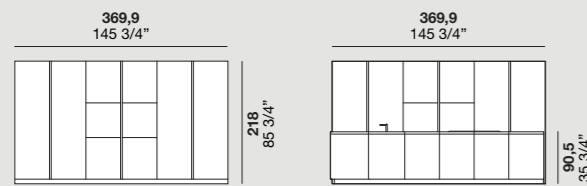

colonne
tall units

pensili / basi
wall units / Base units

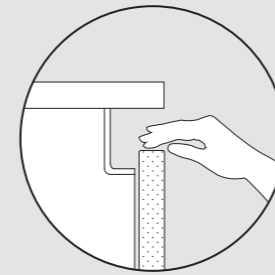

apertura con gola curva
opening with curved groove



basi
base units

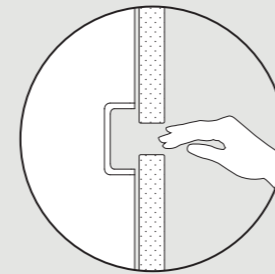

apertura con gola curva
opening with curved groove



colonne
tall units



comp. L / 11

finitura / finish
Laminam Bianco assoluto /
Absolute white Laminam





comp. L / 11

→ IT

Basi laccato opaco Bianco
Maniglia "CG80" Acciaio godronato
Zoccolo laccato opaco Bianco
Top Laminam Bianco assoluto
Pensili laccato opaco Bianco
Elementi "Pass" laccato opaco Tè verde
Colonne laccato opaco Tè verde

Libreria **MY SPACE** laccato opaco Tè verde
 (per questo articolo vedi MY

SPACE / Spazio alle emozioni)

Tavolo **ALIANTE** e sedia **CORIUM**
 (per questi articoli vedi **COMPLEMENTI** / Il senso dei dettagli)

→ EN

Matt lacquered Bianco **base units**
"CG80" handle, knurled steel
 Matt lacquered Bianco **plinth**
 Absolute white Laminam **top**
 Matt lacquered Bianco **wall units**
 Matt lacquered Tè Verde **"Pass" units**
 Matt Tè Verde lacquered **tall units**

Matt lacquered Tè Verde **MY**

SPACE bookcase
 (Please see MY SPACE / Space to emotions for this item)

ALIANTE table and **CORIUM** chair
 (Please see **COMPLEMENTI** / A sense of detail for these items)

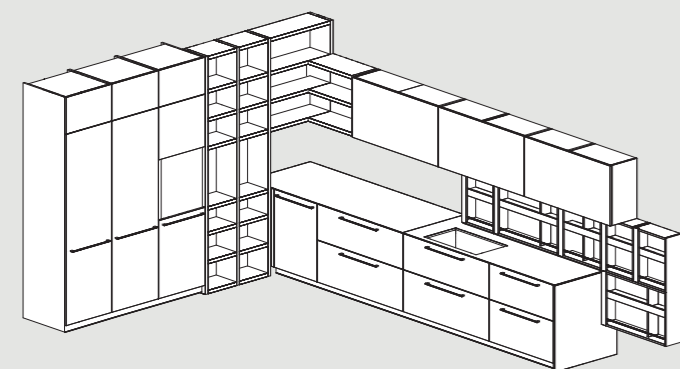

Logica 11

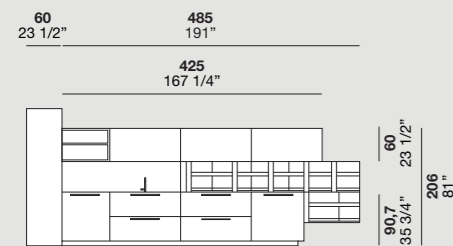

elemento Pass / pensili / basi
 "Pass" unit / wall units / base units

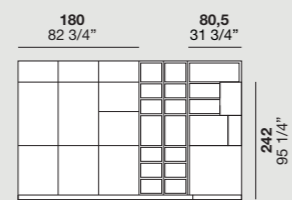

libreria MySpace / colonne
 MySpace bookcase / tall units

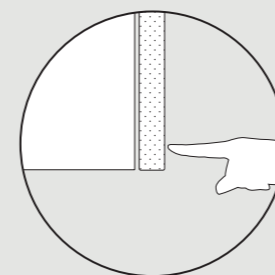

apertura push pull
 push-pull opening

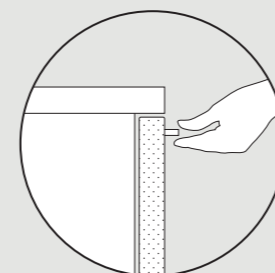

apertura con maniglia
 opening with handle

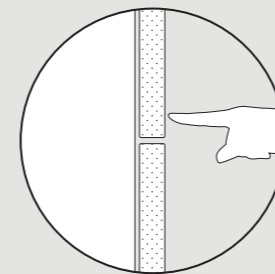

apertura push pull
 push-pull opening

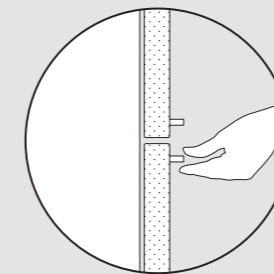

apertura con maniglia
 opening with handle



pensili
 wall units



basi
 base units



colonne
 tall units















comp. L / 12

→ IT

Basi laccato lucido Platino
Maniglia "T19" Moka Shine
Zoccolo laccato opaco Platino
Top Marmo Grafite levigata
Piano tavolo "Diamante"
 Rovere antico Naturale

Colonne Fashion wood Rovere

Carbone

Gola laccato opaco Moka Shine
Zoccolo laccato opaco Moka Shine

Dispensa scaffale "Soho"
 struttura metallo verniciato
 Ghisa / mensole Fashion wood
 Rovere Carbone

→ EN

High gloss lacquered Platino
base units
 Moka Shine "T19" handle
 Matt lacquered Platino plinth
 Smoothed Graphite marble top
 Natural aged-look oak
"Diamante" tabletop

Carbone oak Fashion Wood tall

units

Moka Shine matt lacquered
groove
 Matt lacquered Moka Shine
plinth

"Soho" pantry shelf unit, Ghisa
 painted metal frame / Carbone
 oak Fashion Wood shelves
 Fashion wood Rovere Carbone

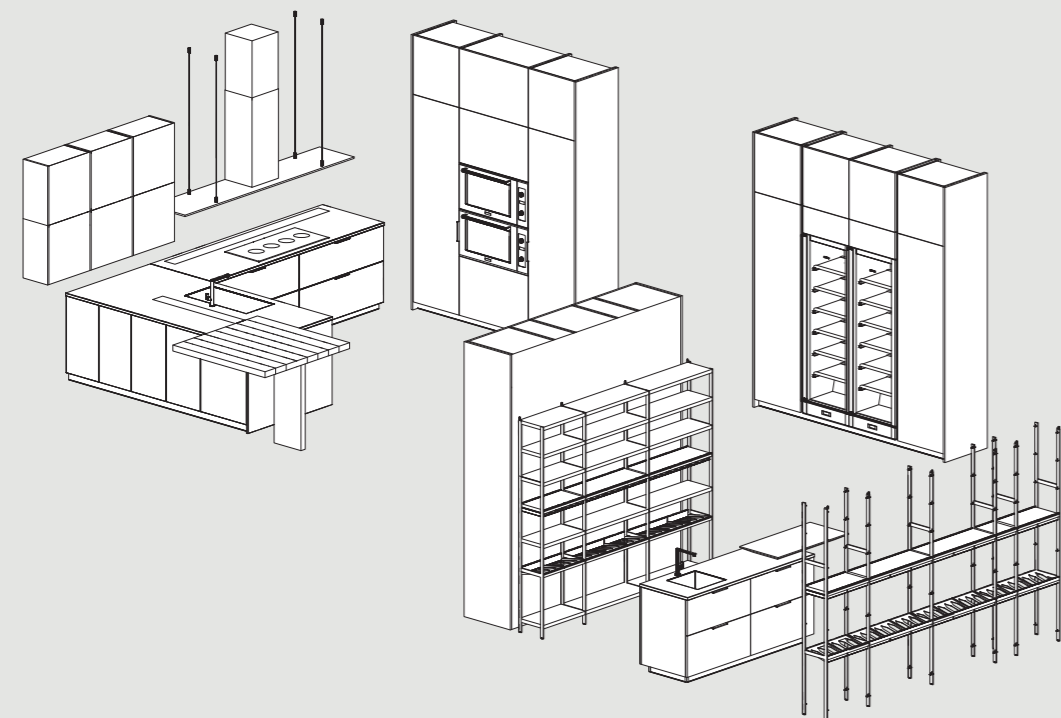

Logica 12

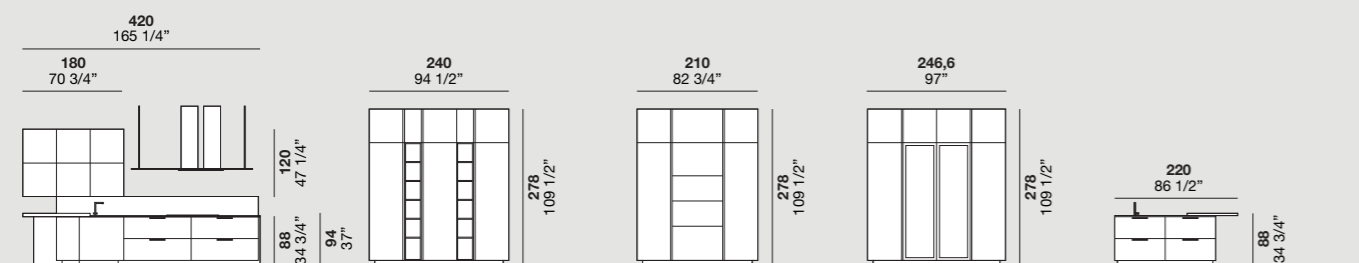

pensili / basi
 wall units / base units

colonne
 tall units

base con snack
 base unit with breakfast bar

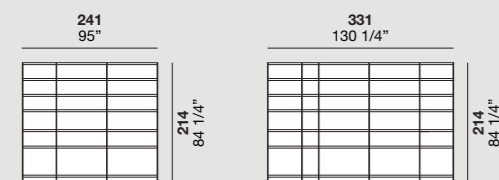

dispensa scaffale
 pantry shelf unit

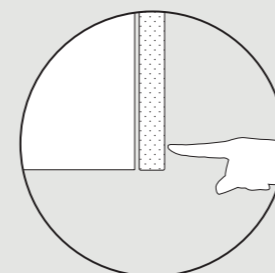

apertura push pull
 push-pull opening

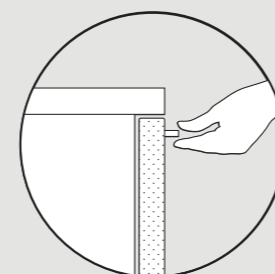

apertura con maniglia
 opening with handle

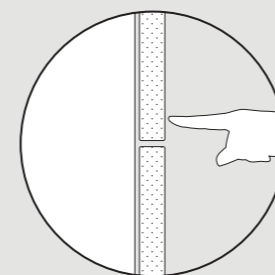

apertura push pull
 push-pull opening

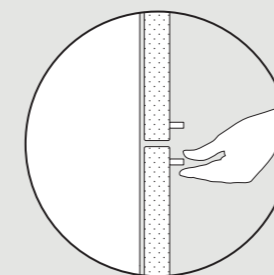

apertura con maniglia
 opening with handle

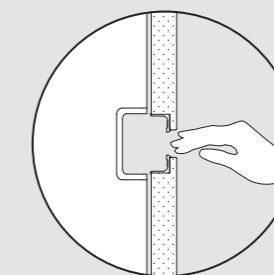

apertura con gola curva
 curved groove opening

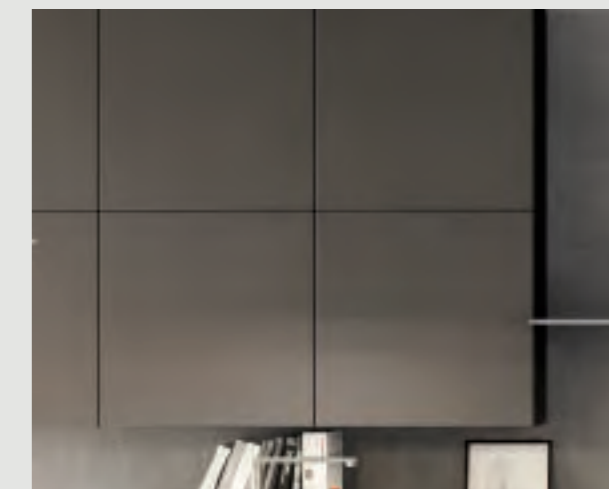

pensili
 wall units



basi
 base units



colonne
 tall units

comp. L / 13



comp. L / 13

LOGICA

finiture / finishes
Marmo Marquinia anticato / Marquinia anticato marble
Laccato opaco Modica / Matt lacquered Modica
Diamante Fashion wood rovere Carbone / Fashion wood Carbone oak Diamante

Valdesign





comp. L / 13

→ IT

Basi laccato opaco Modica
Zoccolo Moka shine
Top marmo Marquinia anticato
Piano tavolo Diamante Fashion
wood rovere Carbone

Colonne laccato opaco Modica
Gola e zoccolo Moka shine

→ EN

Matt lacquered Modica **base units**
Moka shine **plinth**
Marquinia anticato **marble top**
Fashion wood Carbone oak
Diamante **top**

Matt lacquered Modica **tall units**
Moka shine **plinth**

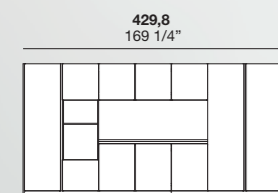

colonne
tall units

429,8
169 1/4"

92,5 65,5 60
36 23 23
1/2" 3/4" 1/2"

218
85 3/4"

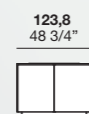

basi
base units

123,8
48 3/4"

153,8
60 1/2"

123,8
48 3/4"

89 6
35" 1/2"



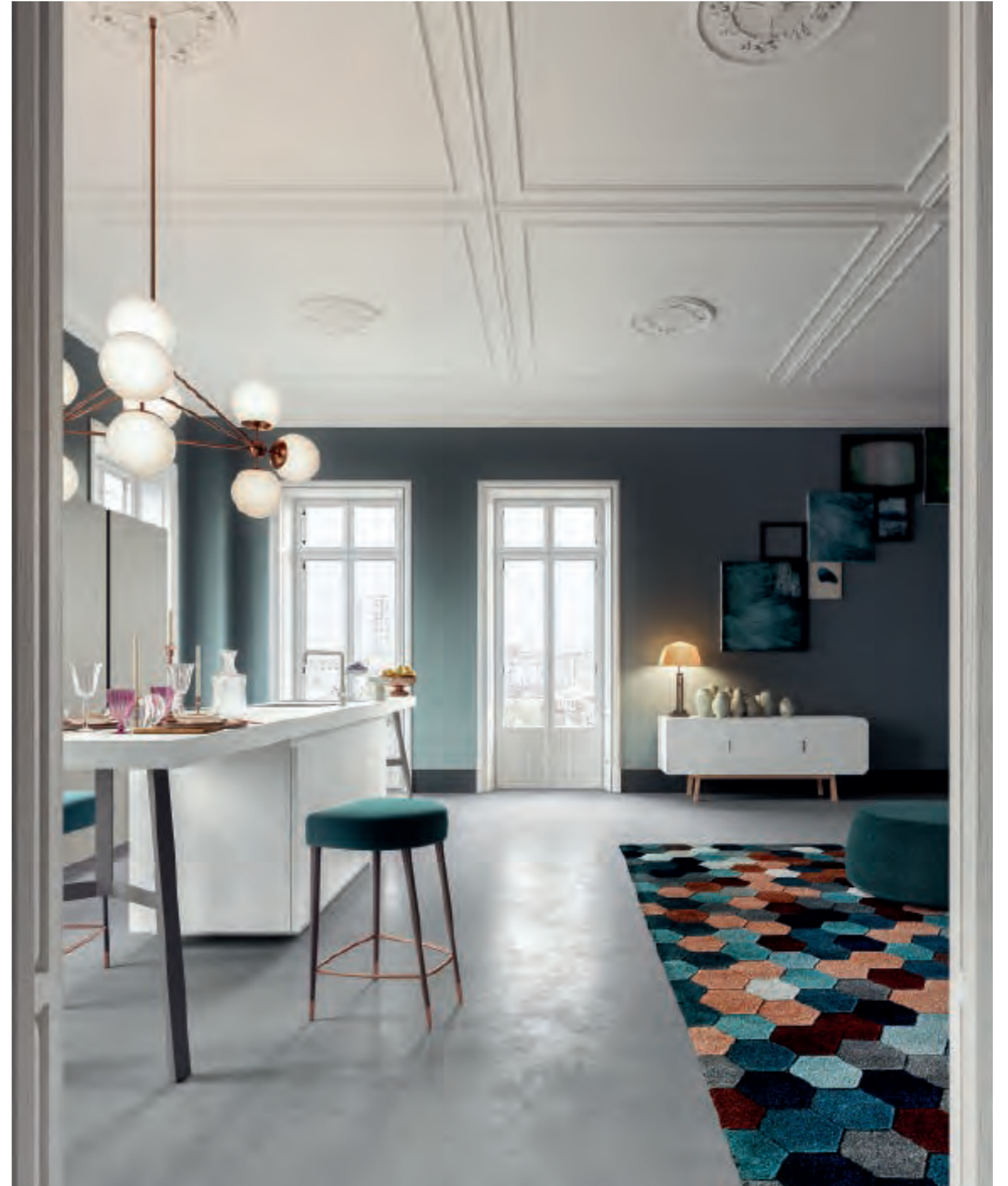







comp. **L / 14**

→ **IT**

Basi laccato opaco Bianco
Gola e **profilo "L40"** laccato opaco Bianco

Zoccolo laccato opaco Bianco
Top Fenix Bianco kos
Gamba penisola **"Titan"** Moka Shine

Colonne Laccato opaco Platino
Gola laccato opaco Platino
Profilo "L40" Moka Shine

Credenza **CARTELEGNO**
(per questo articolo vedi
COMPLEMENTI / Il senso dei
dettagli)

→ **EN**

Matt lacquered Bianco **base units**
Matt lacquered Bianco groove and **"L40" profile**

Matt lacquered Bianco **plinth**
Fenix Bianco Kos **top**
Moka Shine **"Titan"** peninsula leg

Matt lacquered Platino **tall units**
Matt lacquered Platino **groove**
Moka Shine **"L40" profile**

CARTELEGNO sideboard
(Please see COMPLEMENTS / A sense of detail for this item)

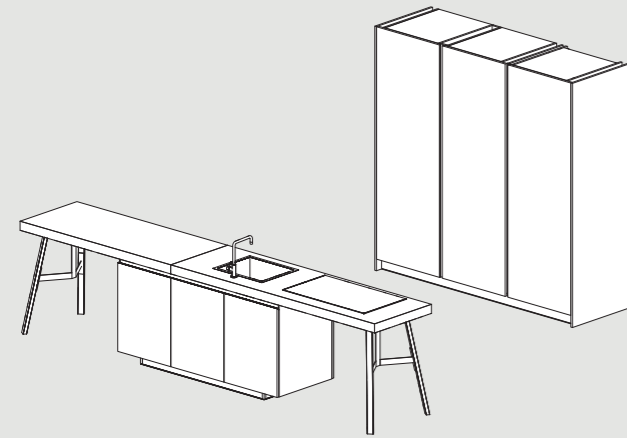

Logica 14

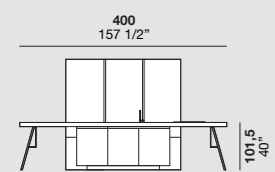

bar snack
breakfast bar base unit

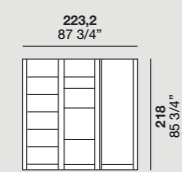

colonne ante rientranti
tall unit with retractable doors

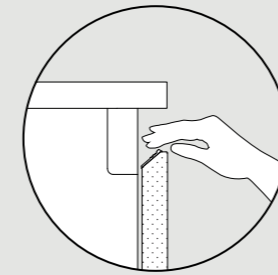

apertura con gola piatta / profilo L40
Opening with flat groove and L40 profile



basi
base units

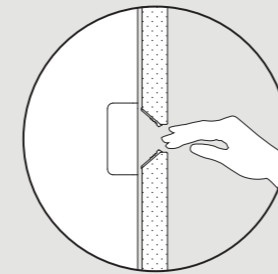

apertura con gola piatta / profilo L40
Opening with flat groove and L40 profile



colonne
tall units

comp. L / 15

→ IT

Basi laccato opaco Calce
Gola e zoccolo laccato opaco Calce
Top Corian Glacier white

Pensili laccato opaco Calce

Moduli Pass Fashion wood rovere Naturale

Piano snack Fashion wood rovere Naturale
Gamba penisola laccato opaco Calce

Colonne Fashion wood rovere Naturale
Gola e zoccolo laccato opaco Calce

→ IT

Matt lacquered Calce **base units**
Moka shine **groove and plinth**
Corian Glacier white **top**

Matt lacquered Calce **wall units**

Fashion wood Naturale oak **Pass modules**

Fashion wood Naturale oak **snack table**
Matt lacquered Calce **leg for table**

Matt lacquered Calce **wall units**
Moka shine **groove and plinth**

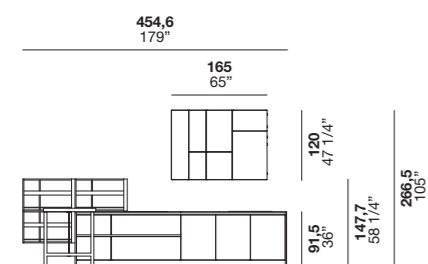

pensili / basi
wall units / base units

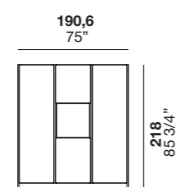

colonne
tall units









comp. L / 16

→ IT

Basi Nobilitato Rasato
Gola laccato opaco Platino
Zoccolo laccato opaco Platino
Top K-Proof Gaja Venus
 Sandlite

Colonne Nobilitato Rasato
Gola laccato opaco Platino
Zoccolo laccato opaco Platino

Pensili Nobilitato Rasato

Libreria pensile "Iron" telaio verniciato Bianco, **mensole** laccato opaco Tortora

Tavolo **ALIANTE** e sedia **KAROL**
 (per questi articoli vedi **COMPLEMENTI** / Il senso dei dettagli)

→ EN

Stucco-look surfaced **base units**
 Matt lacquered Platino **groove units**
 Matt lacquered Platino **plinth**
 K-Proof Gaja Venus Sandlite **top**

Stucco-look surfaced **tall units**
 Matt lacquered Platino **groove**
 Matt lacquered Platino **plinth**

Stucco-look surfaced **wall units**

"Iron" bookcase wall unit, Bianco painted **frame**, matt lacquered Tortora **shelves**

ALIANTE table and **KAROL** chair
 (Please see **COMPLEMENTI** / A sense of detail for these items)

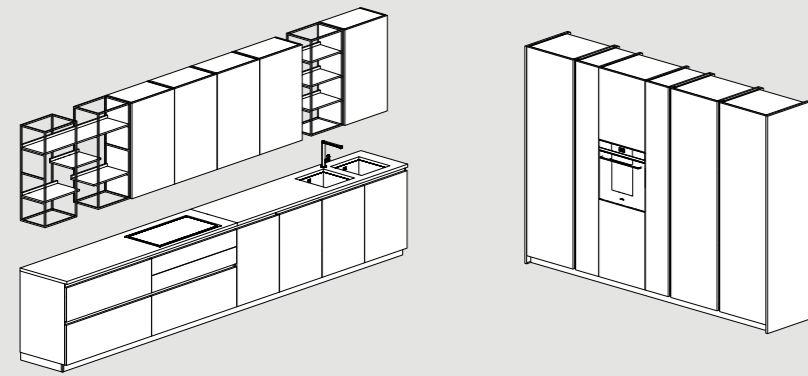

Logica 16

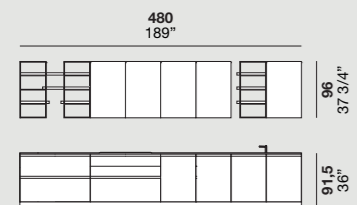

pensili Airon / pensili / basi
 Airon wall units / wall units / base units

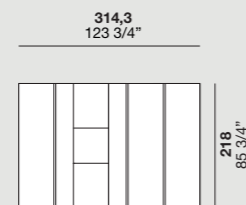

colonne
 tall units

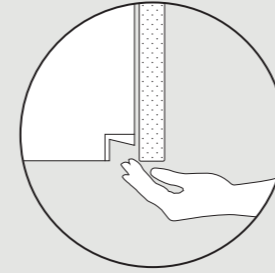

profilo gola
 opening with groove profile

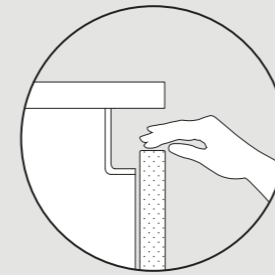

gola curva
 curved groove opening

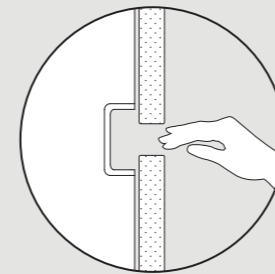

gola curva
 curved groove opening



pensili
 tall units



basi
 base units



colonne
 tall units

comp. L / 17



finiture / finishes
Laminam Nero assoluto
Laccato opaco Nero / Matt lacquered Nero
Noblitato Noce cenere / Surfaced Noce cenere



comp. L / 17

→ IT

Basi laccato opaco Nero
Gola, profilo "L40" e zoccolo
Nero opaco
Top Laminam Nero assoluto

Pensili laccato opaco Nero /
Noblitato Noce cenere

Colonne laccato opaco Nero
Gola e zoccolo Nero opaco

Tavolo **FUSELLO** e sedia **SHIFT**
(per questi articoli vedi
COMPLEMENTI / Il senso dei
dettagli)

→ EN

Matt lacquered Nero **base units**
Matt Nero **groove, "L40" profile**
and **plinth**
Laminam Nero assoluto **top**

Matt lacquered Nero / Surfaced
Cenere Walnut **wall units**

Matt lacquered Nero **wall units**
Moka shine **groove and plinth**

FUSELLO table and **SHIFT** chair
(Please see COMPLEMENTS / A
sense of detail for these items)

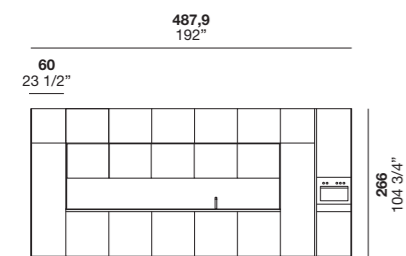

pensili / basi / colonne
wall units / base units / tall units











comp. L / 18

→ IT

Basi Laccato opaco Aghata
Gola laccato opaco Aghata
Zoccolo laccato opaco Aghata
Top Corian Glacier White
Vano a giorno Fashion wood
 Rovere Naturale

Colonne Laccato opaco Aghata
Gola laccato opaco Aghata
Zoccolo laccato opaco Aghata

Pensili Laccato opaco Aghata
 Libreria **MY SPACE** Fashion
 Wood Rovere Naturale
 (per questo articolo vedi MY
 SPACE / Spazio alle emozioni)

Madia **CARTALEGNO**, tavolo
ALIANTE e sedia **AILERON**
 (per questi articoli vedi
 COMPLEMENTI / Il senso dei
 dettagli)

→ EN

**Matt lacquered Aghata base
 units**
 Matt lacquered Aghata **groove
 units**
 Matt lacquered Aghata **plinth**
 Natural oak Fashion Wood open
compartment

Matt lacquered Aghata **tall
 units**
 Matt lacquered Aghata **groove
 units**
 Matt lacquered Aghata **plinth**

**Matt lacquered Aghata wall
 units**
 Natural oak Fashion Wood **MY
 SPACE** bookcase
 (Please see MY SPACE / Space
 to emotions for this item)

CARTALEGNO sideboard,
ALIANTE table and **AILERON**
 chair
 (Please see COMPLEMENTS / A
 sense of detail for these items)

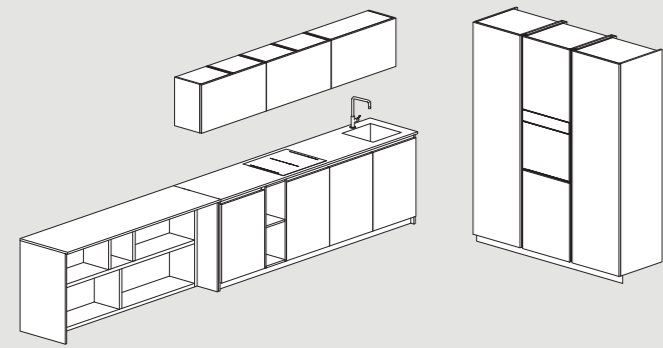

Logica 18

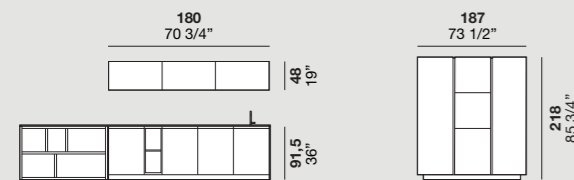

pass / pensili / basi
 pass / wall units / base units

colonne
 tall units

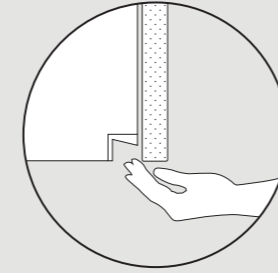

profilo gola
 opening with groove profile



pensili
 tall units

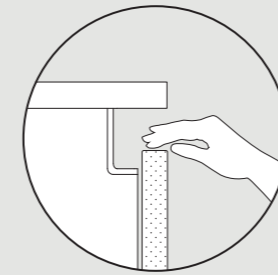

gola curva
 curved groove opening



basi
 base units

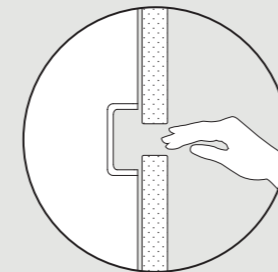

gola curva
 curved groove opening



colonne
 tall units

comp. L / 19



finitura / finish
Fenix Grigio Londra

comp. L / 19

→ **IT**
Basi Fenix Grigio Londra
Gola e zoccolo Moka shine
Piano Fenix Grigio Londra

Pensili Fenix Grigio Londra

Colonne Fenix Grigio Londra
Gola e zoccolo Moka shine

→ **EN**
 Fenix Grigio Londra **base units**
 Moka shine **groove and plinth**
 Fenix Grigio Londra **top**

Fenix Grigio Londra **wall units**

Fenix Grigio Londra **tall units**
 Moka shine **groove and plinth**

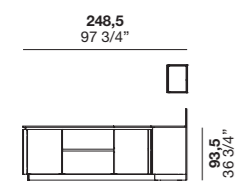

pensili / basi
 wall units / base units

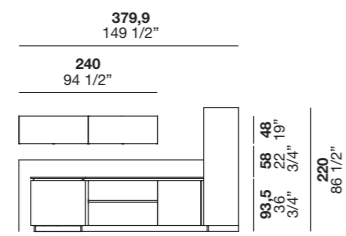

pensili / basi
 wall units / base units

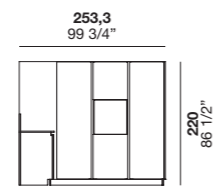

colonne
 tall units



comp. L / 20

finitura / finish
Acciao / K-Proof Gaja moon sandlite /
Steel / K-Proof Gaja Moon Sandlite











comp. L / 20

→ IT

Basi Fashion wood Rovere

Fossile

Maniglia "G40" Inox

Zoccolo laccato opaco Moka Shine

Top Acciaio / K-Proof Gaja moon

sandlite

Elementi "Pass" Fashion wood

Rovere Fossile / Olmo Chiaro

Pensili Fashion wood Rovere

Fossile / Olmo Chiaro

Piano tavolo "Axia" Olmo

Chiaro e gamba Titanio

Sedia **KAROL WOOD**

(per questo articolo vedi

COMPLEMENTI / Il senso dei

dettagli)

Colonne Laccato opaco Arena

Modulo a giorno Fashion wood

Rovere Fossile

Zoccolo laccato opaco Moka

Shine

Gola laccato opaco Moka Shine

→ EN

Fossile oak Fashion Wood **base**

units

Inox "G40" **handle**

Matt lacquered Moka Shine

plinth

Steel / K-Proof Gaja Moon

Sandlite top

Fossile oak Fashion Wood /

Chiaro elm "**Pass**" **units**

Fossile oak Fashion Wood /

Chiaro elm **wall units**

Chiaro elm "**Axia**" **tabletop** and

Titanio leg

KAROL WOOD chair

(Please see COMPLEMENTS / A

sense of detail for this item)

Matt lacquered Arena **tall units**

Fossile oak Fashion Wood **open**

unit

Matt lacquered Moka Shine

plinth

Moka Shine matt lacquered

groove

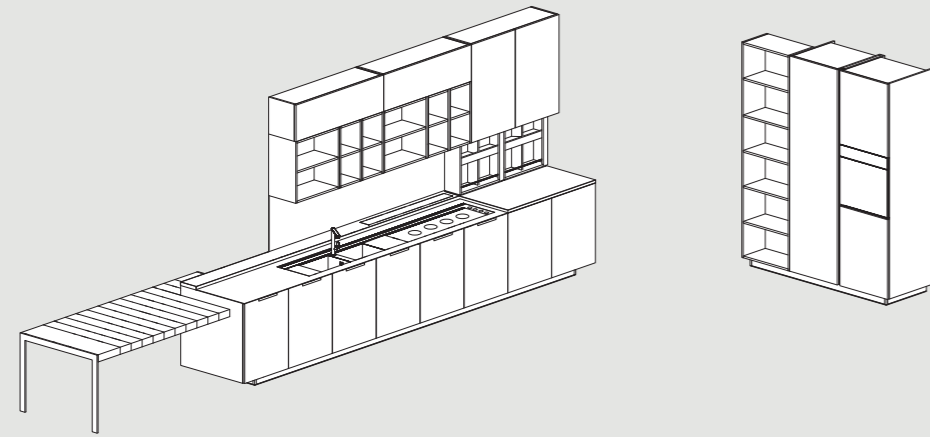

Logica 20

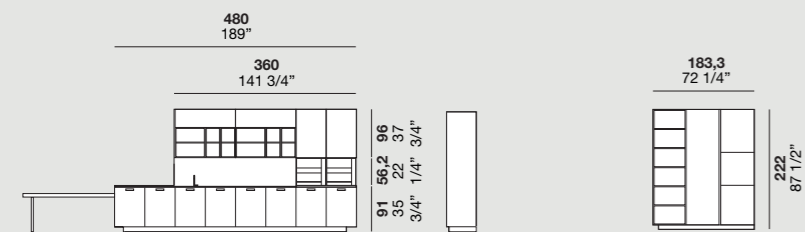

tavolo Axia
Axia table

pensili a giorno / basi / pass
open wall units / base units / pass

colonne
tall units

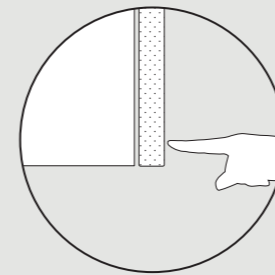

push pull
Push-pull opening

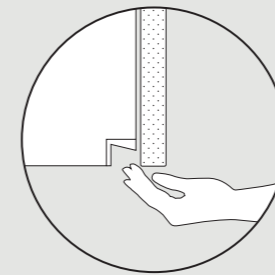

gola
Opening with groove profile

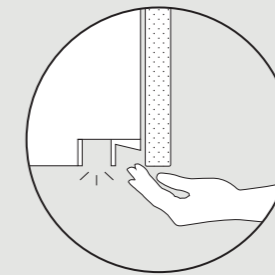

gola / led
Opening with LED groove profile

pensili
wall units

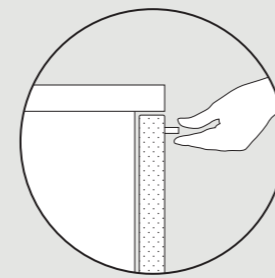

maniglia
Opening with handle

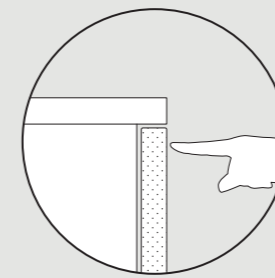

push pull
Push-pull opening



basi
base units

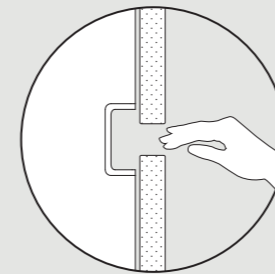

gola curva
curved groove opening



colonne
tall units

comp. L / 21

→ **IT**
Basi laccato opaco Origano
Gola e **zoccolo** Moka shine
Top acciaio

Modulo Pass laccato opaco
Platino

Colonne laccato opaco Origano
Gola e **zoccolo** Moka shine

Tavolo **LE20** e sedia **AILERON**
(per questi articoli vedi
COMPLEMENTI / Il senso dei
dettagli)

→ **EN**
Matt lacquered Origano **base**
units
Moka shine **groove** and **plinth**
Steel **top**

Matt lacquered Platino **Pass**
modules

Matt lacquered Origano **wall**
units
Moka shine **groove** and **plinth**

LE20 table and **AILERON** chair
(Please see COMPLEMENTS / A
sense of detail for these items)

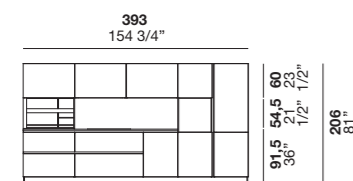

pensili / basi
wall units / base units

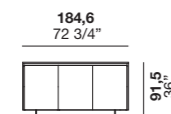

basi
base units

comp. L / 22

finitura / finish
Marmo Marron Emperador spazzolato /
Brushed Emperador Marron marble









comp. L / 22

→ IT

Basi Fashion wood Rovere
Carbone

Gola laccato opaco Piombo

Zoccolo laccato opaco Piombo

Top Marmo Marron Emperador
spazzolato

Colonne Fashion wood Rovere
Carbone

Gola laccato opaco Piombo

Zoccolo laccato opaco Piombo

Pensili laccato lucido Piombo

Elementi "Pass" laccato opaco
Piombo / Fashion wood Rovere
Carbone

Tavolo **LE20** e sedia **VIKY 3**
(per questi articoli vedi
COMPLEMENTI / Il senso dei
dettagli)

→ EN

Carbone oak Fashion Wood
base units

Matt Piombo lacquered **groove**
Matt Piombo lacquered **plinth**
Brushed Emperador Marron
marble **top**

Carbone oak Fashion Wood **tall**
units

Matt Piombo lacquered **groove**

Matt Piombo lacquered **plinth**

High-gloss lacquered Piombo
wall units

Matt lacquered Piombo /
Carbone oak Fashion Wood
"Pass" units

LE20 table and **VIKY 3** chair
(Please see COMPLEMENTS / A
sense of detail for these items)

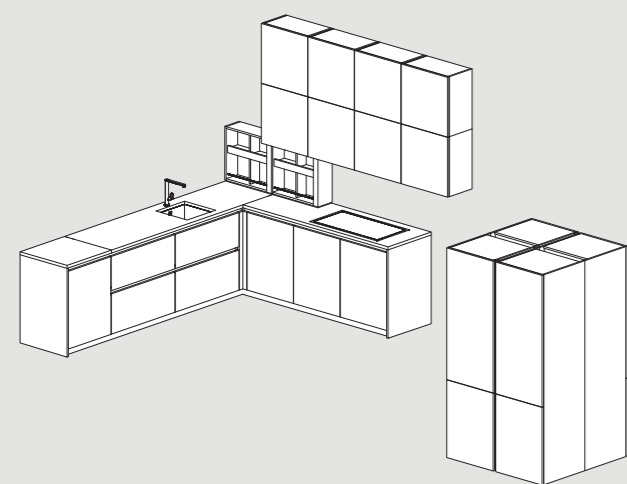

Logica 01

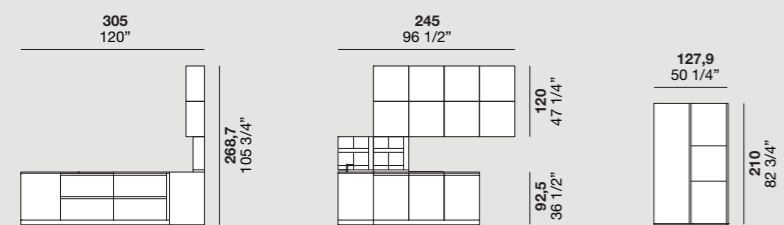

basi
base units

pass / pensili / basi
pass / wall units / base units

colonne
tall units

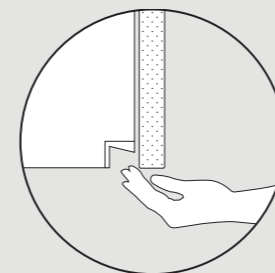

profilo gola
opening with groove profile



pensili
tall units

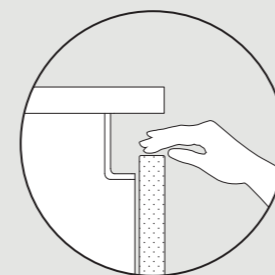

gola curva
curved groove opening



basi
base units

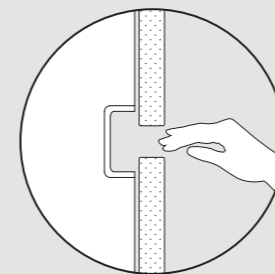

gola curva
curved groove opening

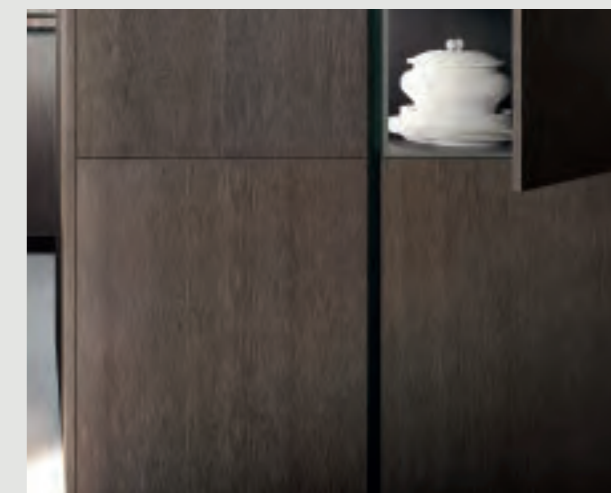

colonne
tall units

Aperture / Opening system



Con LOGICA puoi scegliere fra vari sistemi di apertura per le ante ed i cassetti: decidi quale ti piace di più.

With LOGICA, you can choose from different opening mechanisms for your doors and drawers: you decide which you like best.

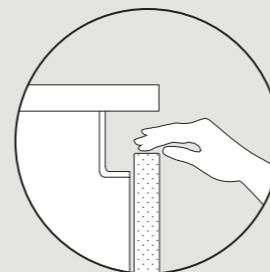

LOGICA L0

apertura con gola curva
curved groove opening

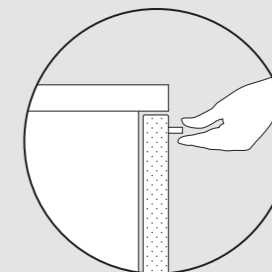

apertura con maniglia
opening with handle

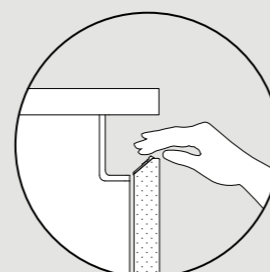

LOGICA L40

apertura con gola curva / profilo L40
opening with curved groove and L40 profile

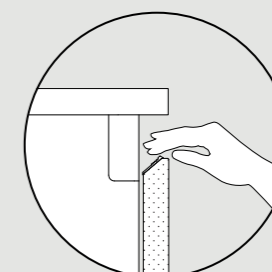

apertura con gola piatta / profilo L40
opening with flat groove and L40 profile

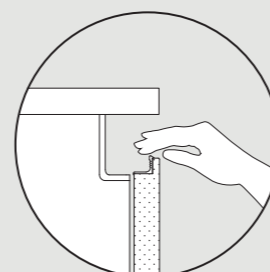

LOGICA L90

apertura con gola curva / profilo L90
opening with curved groove and L90 profile

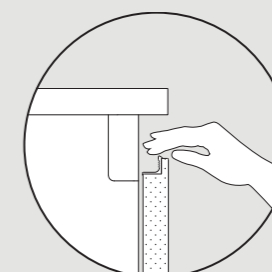

apertura con gola piatta / profilo L90
opening with flat groove and L90 profile

**Novità
di prodotto**
/
**New product
features**



Valdesign migliora e aggiorna costantemente i suoi prodotti dotandoli delle più recenti soluzioni tecniche.

Valdesign is constantly improving and updating its products, fitting them with the latest hi-tech mechanisms and features.

→ **IT**

01 / NUOVA MODULARITÀ

La modularità delle nostre cucine è stata ottimizzata e ampliata in base alle rinnovate esigenze del mercato, come l'aggiunta delle colonne H 216 cm e dei pensili H 78 cm. Oggi l'offerta è di 397 basi, 686 pensili e 432 colonne.

02 / NUOVI MECCANISMI

Per le ante con apertura vasistas di grandi dimensioni utilizziamo nuovi meccanismi più compatti rispetto al passato, dotati di cover in tinta scocca.

03 / SCOCHE PIÙ ROBUSTE E CONTENITORI INTERNI PIÙ CAPIENTI

Le nostre scocche oggi sono più robuste grazie alla schiena di spessore maggiorato: 6,5 mm in luogo dei 3,5 mm precedenti, inoltre nelle basi Profondità 57,5 i cassetti e cesti interni hanno maggiore capienza grazie ad una profondità di 50 cm in luogo dei 45 cm precedenti.

04 / NUOVE SPONDE CASSETTO

Il programma Logica propone la nuova sponda cassetto NOVA PRO SCALA, con le seguenti caratteristiche tecniche:

- Estrazione totale, Carico complessivo sopportato 40 / 70 kg
- Durata 60.000 cicli, Design funzionale ed ergonomico
- Elevato comfort d'utilizzo grazie all'ammortizzazione integrata
- Silenziosità di funzionamento
- Facilità di montaggio
- Due finiture disponibili: Antracite o Nero
- Frontale in alluminio sp. 8 mm per cassetti o cesti interni
- Maggiore capienza per cassetto con frontale H 24 cm (10 cm di altezza in più rispetto al precedente).



01



02

→ **EN**

01 / NEW MODULAR UNITS

Our modular kitchen compositions have been extended and optimised to meet new market needs. For example, tall units measuring H. 216 cm and wall units measuring H. 78 cm have been added. Today, we offer 397 base units, 686 wall units and 432 tall units.

02 / NEW MECHANISMS

For large doors with a tilt opening, we use new, more compact mechanisms fitted with a cover that matches the body colour.

03 / MORE ROBUST BODIES AND MORE SPACIOUS INTERNAL STORAGE UNITS

Our unit bodies are now more robust, thanks to a thicker back panel measuring 6.5 mm instead of 3.5 mm. In addition, the base units measuring 57.5 in depth have more spacious internal drawers and large drawers, measuring 50 cm in depth instead of 45 cm.

04 / NEW DRAWER SIDEBOARDS

The Logica range includes a new drawer sideboard NOVA PRO SCALA, which has the following technical characteristics:

- Full pull-out, Overall supported load 40 kg / 70 kg
- 60,000 cycles, Functional, ergonomic design
- Ultra-smooth motion thanks to the soft-close mechanism
- Silent - Easy to fit
- Available in two finishes: Antracite and Nero
- Aluminium front, 8 mm thk, for internal drawers or large drawers
- Greater capacity for drawers with front H. 24 cm (10 cm taller than previous models).



03



04



→ IT

05 / MAGGIORE ATTENZIONE ANCHE AI DETTAGLI MENO VISIBILI

Catene scocca in MDF o in ferro verniciate nere anziché argento o finitura acciaio.

Anche i reggiripiani sono completamente nuovi, in tinta scocca per i ripiani legno e in acciaio per quelli vetro.

Senza rinunciare alla funzione, i nostri paracolpi oggi sono più piccoli e "discreti", un altro esempio di attenzione al dettaglio.

06 / NUOVE ATTACCAGLIE A SCOMPARSA

Oggi tutti i nostri pensili sono dotati di attaccaglie "a scomparsa". Una volta aperto il pensile si noterà solo un elegante tappo di chiusura in luogo dell'antiestetico meccanismo a vista.

07 / NUOVO TELAIO PER FRONTALE LAVASTOVIGLIE

Per un perfetto effetto estetico in presenza di affiancamento basi gola con cestoni l'anta lavastoviglie può avere la gola nella stessa posizione.

08 / COLONNE CON ANTE RIENTRANTI

Per colonne con ante rientranti è stata aumentata l'altezza scocca a 210 cm in luogo dei precedenti 204 cm. Nella mini-cucina sono stati aggiunti i top e schienali in Unicolor, Fenix o Corian con vasche integrate nello stesso materiale, inoltre i frontali interni hanno spessore di 2,2 cm e finitura come frontale (prima erano disponibili solo in finitura scocca) Per le ante è stata aggiunta la maniglia P42.



05



06

→ EN

05 / GREATER ATTENTION TO HIDDEN DETAILS

MDF unit body chains either in black painted iron, as opposed to silver, or in a steel finish.

The shelf brackets are also brand new. For wooden shelves, they match the unit body. For glass shelves, they come in steel.

Without compromising on function, our buffer pads are now smaller and more discrete – just another example of our attention to detail.

06 / NEW CONCEALED FASTENERS

Today, all of our wall units come with concealed fasteners. With the wall unit open, all you can see is an elegant cap, instead of the ugly fixture on show.

07 / NEW FRAME FOR DISHWASHER FRONT

For a perfectly polished look alongside base units with a groove and extra-large drawers, the dishwasher door features a groove in the same position.

08 / TALL UNITS WITH RETRACTABLE DOORS

For tall units with retractable doors, the unit body height has been increased from 204 cm to 210 cm. The kitchenettes now feature worktops and backs in Unicolor, Fenix or Corian, with built-in sinks in the same material. The internal fronts are 2.2 cm thick and finished to match the front (previously they were only available in the same finish as the unit body). A P42 handle has been added to the doors.



07



08



→ **IT / LACCATURA**
Il nostro processo di laccatura prevede la spazzolatura nel caso della finitura lucida in tutte le superfici a vista.

→ **EN / LACQUERING**
Our lacquering process includes brushing for glossy finishes on all visible surfaces.

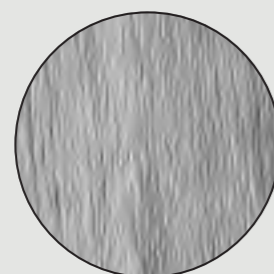

→ **IT / CICLO DI VERNICIATURA**
Le finiture Fashion wood e Rovere laccato sono realizzate con ciclo di verniciatura all'acqua.

→ **EN / PAINTING**
The Fashion Wood and lacquered oak finishes are created using water-based paint.

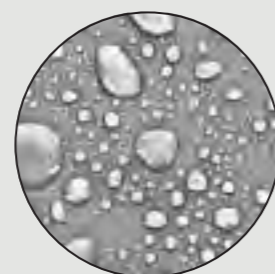

→ **IT / SCOCHE**
Le nostre scocche sono idrorepellenti.

→ **EN / BODIES**
The unit bodies are water repellent.



→ **IT / SCOCHE**
Le nostre scocche sono a bassa emissione di formaldeide secondo normative **EPA** e **CARB**.

→ **EN / BODIES**
Our unit bodies have low formaldehyde emissions according to the **EPA** and **CARB** regulations.

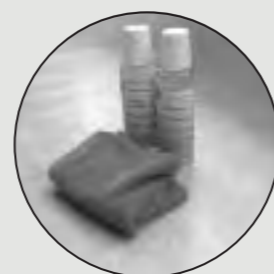

→ **IT / MANUTENZIONE**
Disponibile con maggiorazione Kit per manutenzione e pulizia ante finitura cemento.

→ **EN / CARE**
Cleaning and care kit for cement-finish doors available at a surcharge.

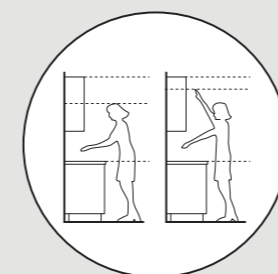

→ **IT / ERGONOMIA**
Grazie alla vasta modularità è sempre possibile realizzare l'ergonomia perfetta.

→ **EN / ERGONOMICS**
Thanks to the vast array of modular units, you can create the perfect ergonomic unit every time.

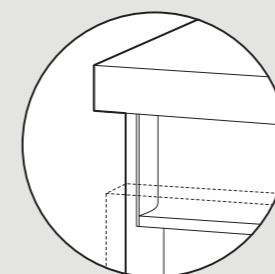

→ **IT / PULIZIA DELLE LINEE**
In presenza di gola il fianco viene "scansato". Questa lavorazione consente di non utilizzare fianchi aggiuntivi.

→ **EN / CLEAN LINES**
Where there is a groove, the side panel is cut to shape. This type of processing means additional side panels are not required.



→ **IT / GUIDE**
I nostri cassetti sono forniti di guide in acciaio con portata collaudata di 40 kg alla coppia per profondità fino a 50 cm e 70 kg alla coppia per profondità 60 cm e movimenti garantiti per 80.000 cicli di apertura e chiusura.

→ **EN / RUNNERS**
The drawers are supplied with steel runners which are tested to support a load of 40 kg per pair for depths up to 50 cm, and 70 kg per pair for depths of 60 cm. Movement guaranteed for 80,000 opening and closing cycles.



→ **IT / FERRAMENTA**
Ogni mobile è fornito di ferramenta per garantire l'affidabilità nel tempo quali cerniere ad innesto rapido con ammortizzatore di chiusura per le ante e guide con chiusura assistita per cassetti e cestoni.

→ **EN / HARDWARE**
Each unit comes with fixtures and fittings to ensure long-lasting reliability. These include snap-in hinges with assisted closing for the doors and soft-close runners for the drawers.

art direction
Brunella Vaccher
Genny Canton

set coordinator/graphic
Genny Canton Studio

digital image location
Nudesign

digital image still
Genny Canton Studio

photo
Cristiano Cecconi
Nicola Picogna
Step photography

separations
Lucegroup

print
Sincromia

stampato 10/2020

Valdesign®

cucine

VALDESIGN srl
Via per Sacile 75
31018 Francenigo di Gaiarine
Treviso, Italy
Tel. +39 0434 769811
Fax +39 0434 769845
www.valdesigncucine.it
info@valdesigncucine.it

Verifica le finiture disponibili sul nostro sito internet. / Check the finishes available on our website. / Consulte los acabados disponibles en nuestro sitio web. / Vérifiez les finitions disponibles sur notre site internet. / Überprüfen Sie auf unserer Webseite, ob die gewünschte Ausführung erhältlich ist. / Познакомьтесь с вариантами отделки на нашем интернет-сайте **www.valdesigncucine.it**

ALF UNO s.p.a. si riserva di apportare in qualsiasi momento modifiche a prodotti, misure e materiali, che ritenesse utili per esigenze di carattere produttivo e commerciale. Per essere sempre aggiornati vi invitiamo a consultare il nostro sito internet www.valdesigncucine.it

LE FINITURE

I materiali utilizzati dalla nostra azienda sono selezionati tra i più affidabili per applicazione e resa estetica. Nonostante questo devono considerarsi tollerabili alcune differenze dovute alle caratteristiche stesse di materiali come essenze naturali, vetri, laccature e all'artigianalità di alcune fasi del processo produttivo che da sempre è un nostro valore aggiunto. Inoltre alcune finiture possono subire nel tempo maturazioni dovute all'azione della luce e del tempo. È importante quindi specificare se nell'ordine vi sono sostituzioni o completamenti per valutare insieme il miglior modo di procedere. Le tonalità di colore e le finiture illustrate vanno considerate puramente indicative. Verificare sempre la fattibilità dell'abbinamento finiture consultando l'interno del listino.

ALF UNO s.p.a. reserves the right to make any changes to products, measurements and materials at any time deemed useful for manufacturing and sales purposes. To stay up to date at all times, please visit our website www.valdesigncucine.it

FINISHES

The materials we use are selected among the most reliable products in terms of application and aesthetic rendering. Despite this, certain differences due to the very characteristics of materials such as natural wood finishes, glass and lacquers must be considered tolerable, as well as the hand-crafted nature of certain phases of the production process, which has always been one of our added values. In addition, some finishes may change over time, due to the effects of light and time. It is therefore important to specify whether there are replacements or completions in the order to assess the best way to proceed together. The finishes featured in this sample collection are purely indicative and are not available for all products. Please check in the price list if the finish is available for the chosen item. Orders will not be accepted for products with finishes not included in the price list. The colour shades and finishes illustrated herein are to be considered purely indicative. Always check the feasibility of finish combinations by consulting the price list contents.

MAGGIORANA



MAGGIORANA

Valdesign[®]
cucine

Cucina della memoria, ricca di ispirazioni naturali, Maggiorana rielabora con l'essenzialità del design moderno il ricordo della campagna veneta. L'olmo, l'albero di ogni cortile, dà vita ad un'anta ritmata ispirata agli steccati d'un tempo, riportando il calore del focolare nella casa contemporanea.



Maggiorana is a keeper of memories, richly inspired by the natural surroundings of the Veneto countryside which reappear in its slick, modern design. Elm trees were a staple of every family's courtyard; here, the wood has been used to create a door design that adds rhythm. Inspired by old-fashioned picket fences, it brings the warm feel of a cosy fire into the contemporary home.

M/01

La composizione Maggiorana M/01 ha una conformazione ad isola con colonne e nicchia dotate di cantinetta e vano contenitivo. Il minimalismo sofisticato si unisce alla funzionalità in uno spazio dove ogni dettaglio è studiato per interpretare al meglio le esigenze di chi lo vive. L'introduzione della nuova anta da 45 permette di creare una ritmica stilistica che esprime libertà progettuale ed eleganza architettonica.

Maggiorana M/01 is structured with an island, featuring tall units and niches fitted a wine rack and storage compartment. Functionality meets sophisticated minimalism, creating a space in which every detail has been designed to best interpret the needs of those who use it. The addition of the new 45 mm door means you can create a stylish sense of rhythm; it leaves you free to design your space and makes for architectural elegance.











Valdesign



comp. M/01

15

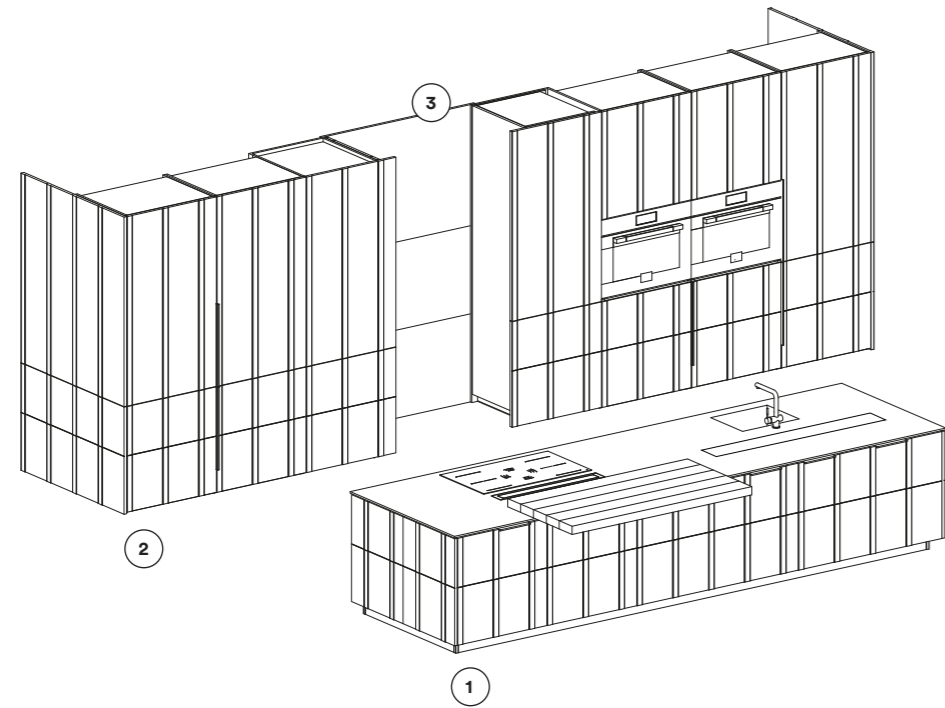

1 BASI / BASE UNITS
 Basi e Piano snack Olmo Carbone, maniglie verniciato Moka Shine, zoccolo Laccato opaco Moka Shine, top Marmo Gray Amani levigato / Base units and Snack top Carbone Elm, handles Moka Shine painted, plinth Moka Shine matt lacquer, top Gray Amani levigato Marble.

2 COLONNE / TALL UNITS
 Colonne Olmo Carbone / Wall units Carbone Elm

2 BOISERIE
 Marmo Gray Amani levigato / Gray Amani levigato Marble

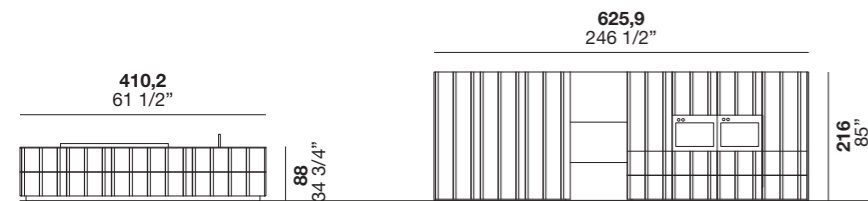

Basi / Base units

Colonne / Tall units

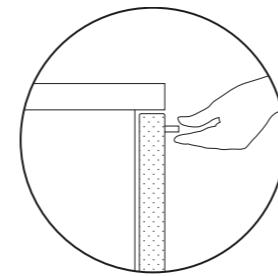

Apertura con maniglia / Opening with handle



Basi / Base units

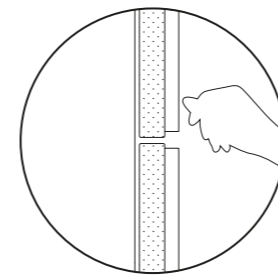

Apertura con maniglia / Opening with handle

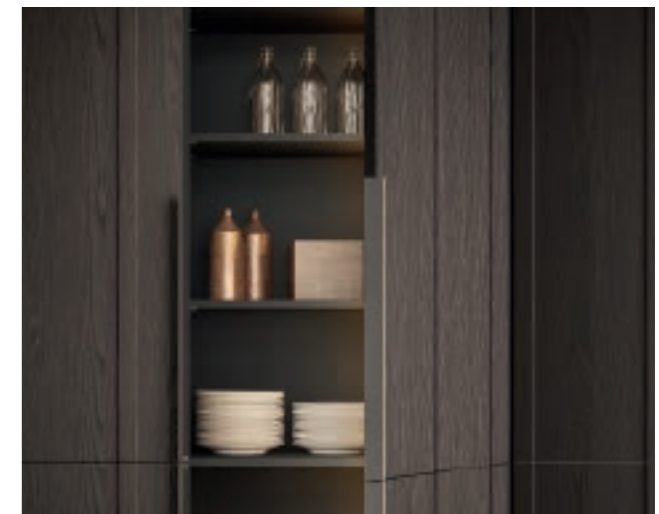

Colonne / Tall units

M/02

Maggiorana M/02 è una composizione lineare a parete con basi e pensili che si arricchisce di una nuova particolarità grazie al modulo con anta in vetro disponibile anche per la base e boiserie a parete dotata di mensole in metallo. Uno spazio dove il design contemporaneo incontra il calore e la solidità dell'olmo naturale.

Maggiorana M/02 is a linear wall composition with base and tall units featuring a new module with a glass door, and boiserie wall panelling with metal shelves. Contemporary design meets the warm, reassuring feel of natural elm in this space.













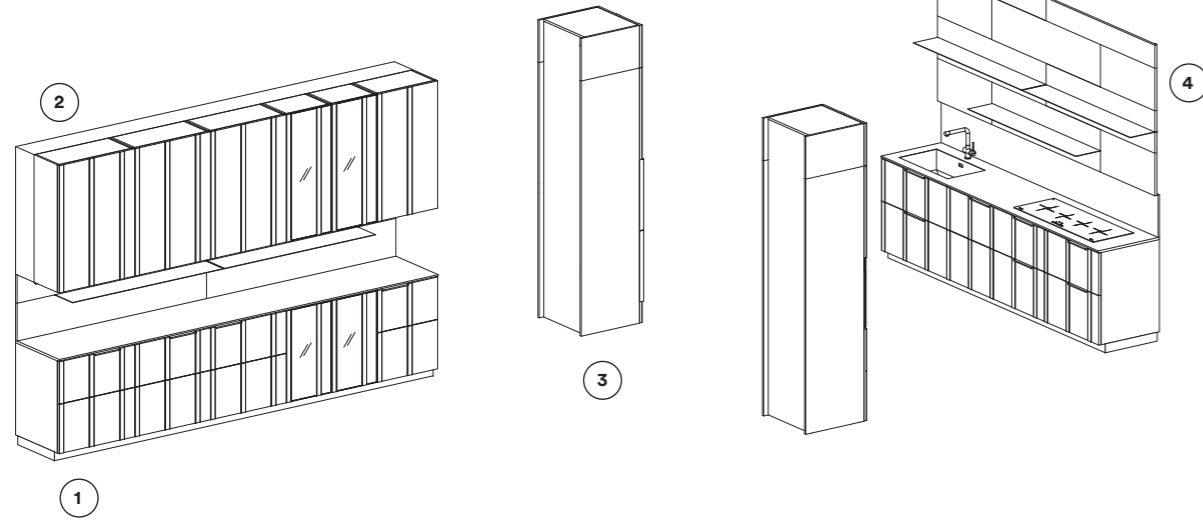

1 BASI / BASE UNITS
 Basi Olmo Chiaro, Ante vetro Trasparente Grigio, maniglie verniciato Moka Shine, zoccolo Laccato opaco Moka Shine, top Laminam Fokos Sale / Base units Chiaro Elm, Grey transparent glass doors, handles Moka Shine painted, plinth Moka Shine matt lacquer, top Fokos Sale Laminam.

2 PENSILI / WALL UNITS
 Pensili Olmo Chiaro, Ante vetro Trasparente Grigio / Wall units Chiaro Elm, Grey transparent glass doors.

3 COLONNE / TALL UNITS
 Olmo chiaro e zoccolo laccato opaco Moka shine / Tall units Chiaro Elm with plinth Moka shine matt lacquer.

4 BOISERIE
 Fashion wood rovere Ghiro, mensole metallo Moka shine / Fashion wood Ghiro Oak, Shelves Moka Shine metal.

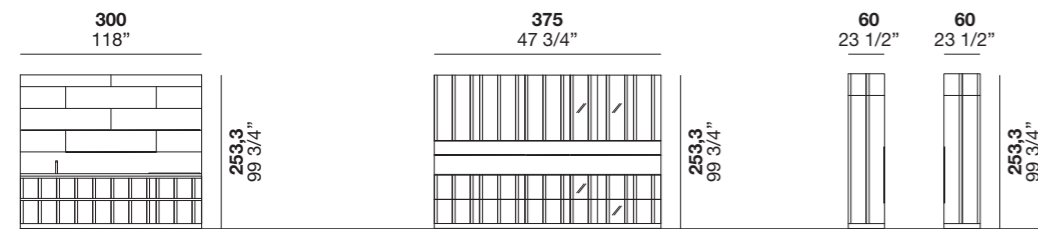

Basi / Base units

Basi / Base units

Colonne / Tall units

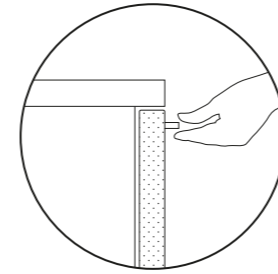

Apertura con maniglia / Opening with handle

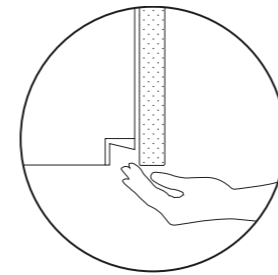

Apertura con gola / Opening with groove

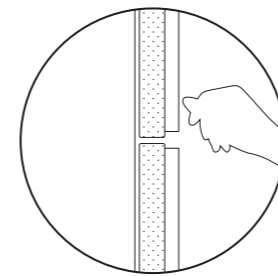

Apertura con maniglia / Opening with handle



Basi / Base units



Pensili / Wall units

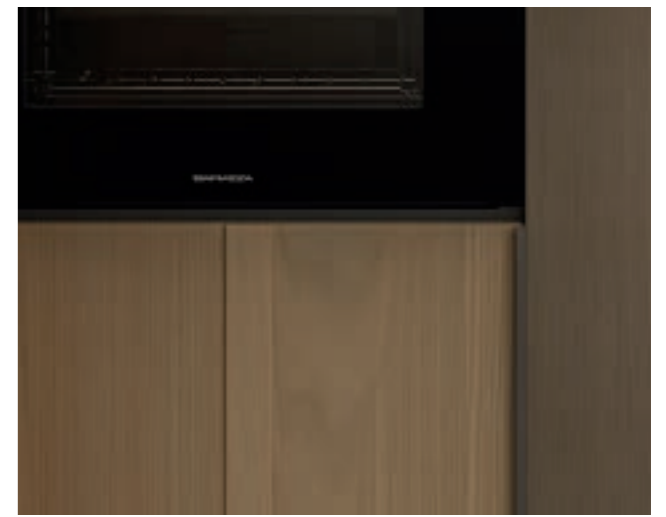

Colonne / Tall units

M/03

Una composizione a due isole e colonna doppia con dispensa scaffale a parete. Questa è la composizione Maggiorana M/03, espressione massima di un design moderno e funzionale, per un vero e proprio laboratorio di sapori e saperi contemporaneo. Uno spazio in cui libertà progettuale e armonia di vivere si fondono assieme.

With two islands, the composition offers double tall units with wall-mounted pantry shelving. Maggiorana M/03 is the ultimate expression of modern, functional design. It creates a laboratory for exploring contemporary flavours and flairs. Be free to create and live harmoniously, all in one space.











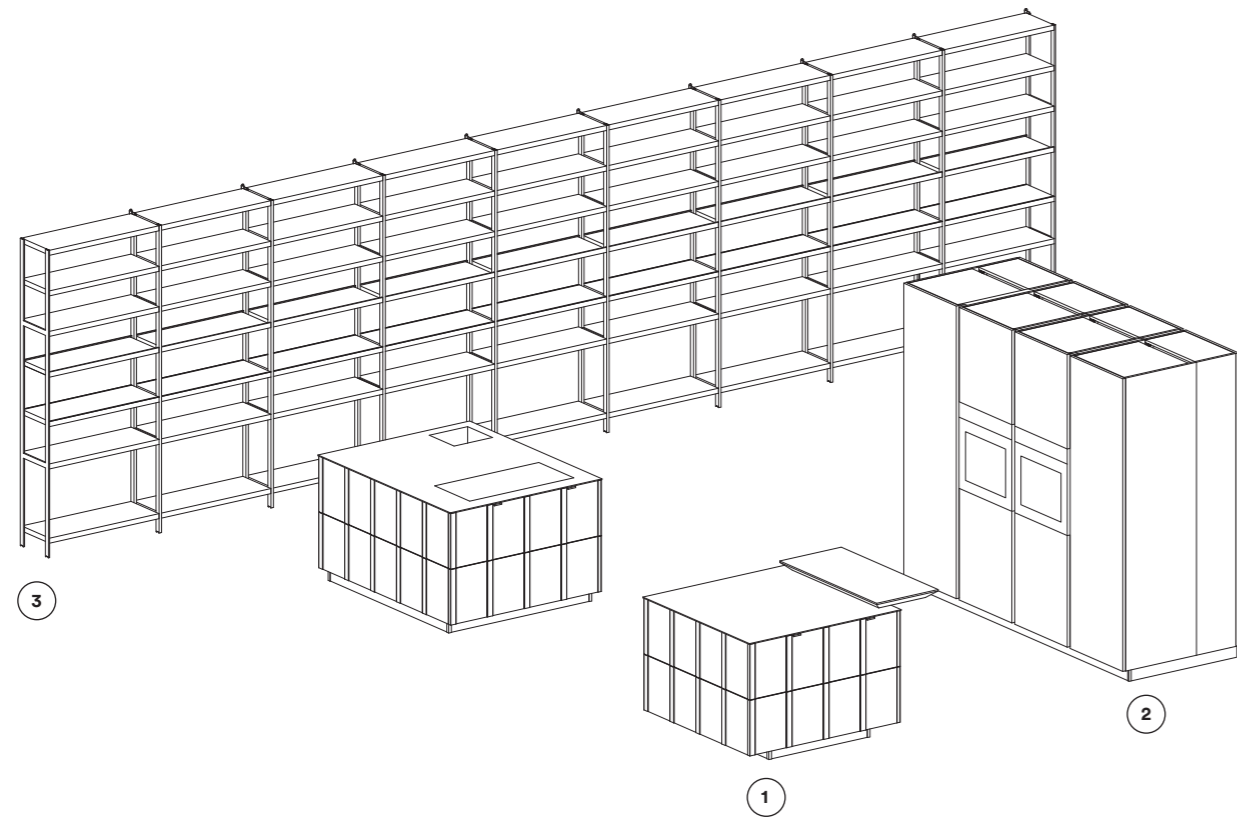

1 BASI / BASE UNITS

Basi Laccato opaco Platino, maniglie verniciato opaco Moka Shine, Zoccolo Laccato opaco Moka Shine, top K-Proof Gaia moon sandlite, Piano snack Olmo Carbone / Base units Platino matt lacquer, handles Moka Shine painted, plinth Moka Shine matt lacquer, top K-Proof Gaia moon sandlite, Snak top Carbone elm.

2 COLONNE / TALL UNITS

Colonne Laccato opaco Platino, Zoccolo Laccato opaco Moka Shine / Wall units Platino matt lacquer, plinth Moka Shine matt lacquer.

3 DISPENSA SCAFFALE / SCAFFALE PANTRY

Dispensa scaffale struttura verniciato Moka Shine, mensole Laccato opaco Platino / Scaffale pantry structure Moka Shine painted, shelves Platino matt lacquer.

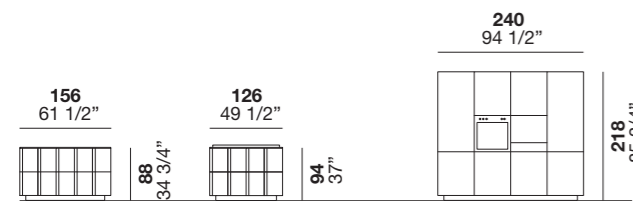

Basi / Base units

Colonne / Tall units

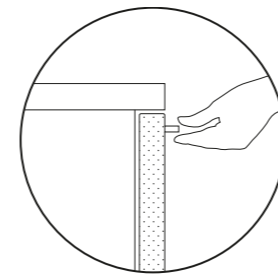

Apertura con maniglia / Opening with handle



Basi / Base units

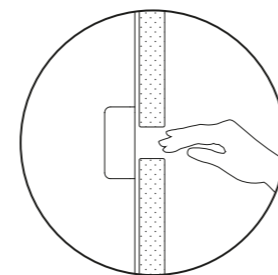

Apertura con gola / Opening with groove



Colonne / Tall units

M/04

Nella composizione Maggiorana M/04 con basi e pensili lineari in vetro, il motivo verticale si ripete nelle sue parti alternando la modernità dell'anta laccata opaca e setosa al tatto con la trasparenza ed eleganza dell'anta in vetro. Uno spazio ricercato dove gli ingredienti, i materiali, trovano libertà di interpretazione per ogni ricetta stilistica e progettuale.

The Maggiorana M/04 composition has a linear look created by glass base and wall units, with a vertical motif that is carried across the design. The visual effect is an alternation between modern, matt lacquered doors with a silky touch and elegant, see-through glass doors. Ingredients and materials can be freely interpreted for every style and design recipe in this refined space.







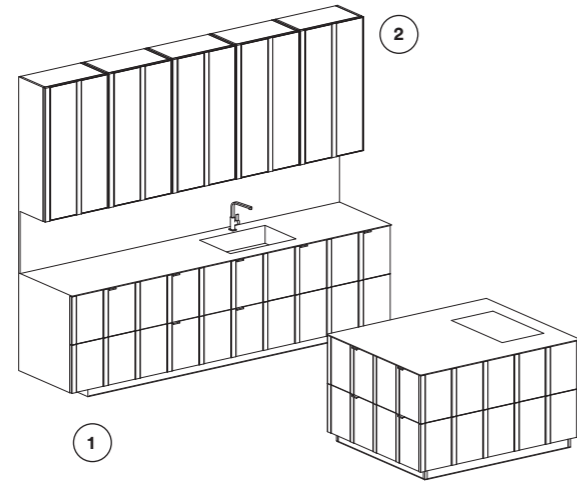

1 BASI / BASE UNITS
 Basi Laccato opaco Fango, maniglie verniciato Moka Shine, zoccolo Laccato opaco Moka Shine, top Marmo Emperador luidido spazzolato / Base units Fango matt lacquer, handles Moka Shine painted, plinth Moka Shine matt lacquer, top Emperador luidido spazzolato Marble.

2 PENSILI / WALL UNITS
 Pensili vetro Trasparente Grigio e Olmo Carbone / Wall units Grey transparent glass and Carbone Elm.

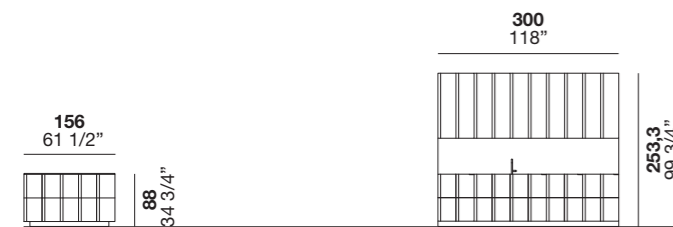

Basi / Base units

Basi e pensili / Base and wall units

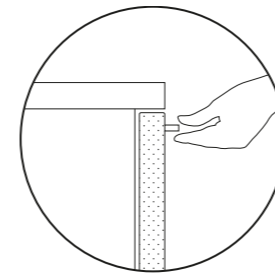

Apertura con maniglia / Opening with handle

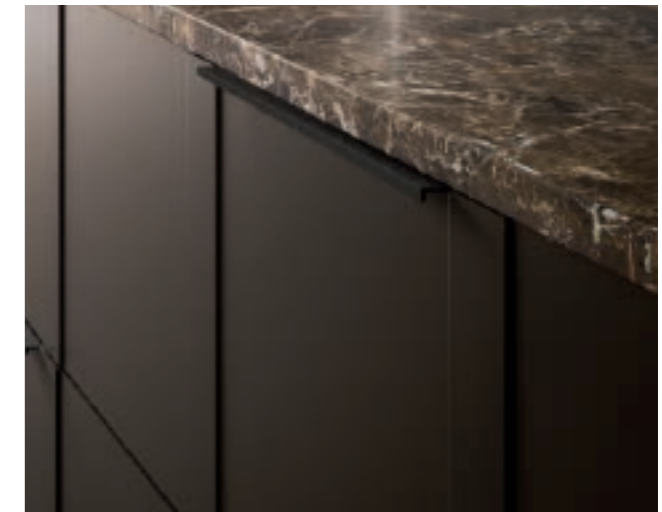

Basi / Base units

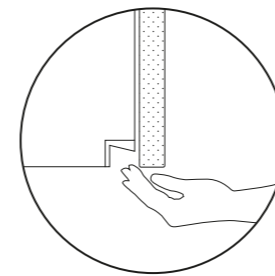

Apertura con gola / Opening with groove

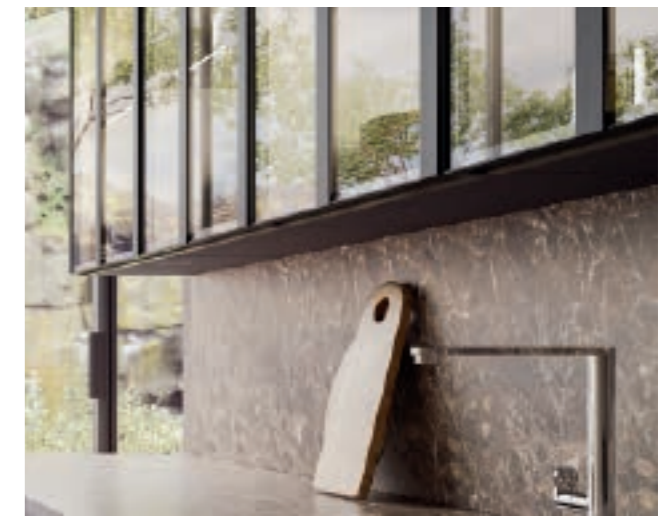

Colonne / Tall units

M/05

Maggiorana è molto più di un concetto: è uno spazio dove i prodotti della terra diventano cibo per la vita. La composizione Maggiorana M/05 con conformazione ad isola e colonne dotate di sistema Ante Rientranti coniuga la funzionalità di questo modulo con l'essenzialità del design moderno, mentre i materiali come l'olmo e la pietra esprimono nell'ambiente il calore domestico tipico della cultura contadina di un tempo.

Maggiorana is much more than just a concept; it's a space in which the earth's fruits become food for life. Maggiorana M/05 is an island composition, fitted with practical pocket-door tall units and boasting a sleek, modern design. Materials like elm wood and stone bring a familiar warmth typical of old-fashioned country living to the space.











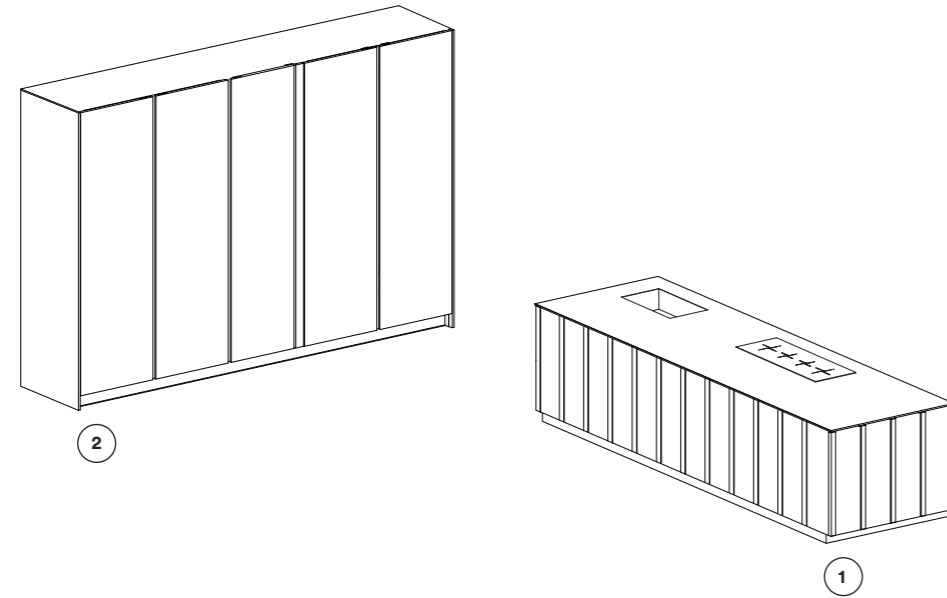

1 BASI / BASE UNITS
 Basi Olmo Carbone, maniglie verniciato opaco Moka Shine, Zoccolo Laccato opaco Arena, top Marmo Marquinia anticato e Acciaio vintage / Base units Carbone Elm, handles Moka Shine painted, plinth Arena matt lacquer, top Marquinia anticato Marble.

2 COLONNE / TALL UNITS
 Colonne con ante rientranti Laccato lucido Arena / Tall units with retractable doors Arena high gloss lacquer.



Basi / Base units

Colonne / Tall units

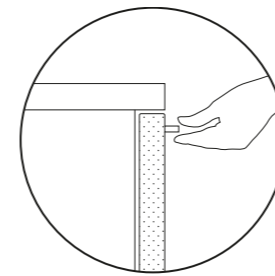

Apertura con maniglia / Opening with handle



Basi / Base units

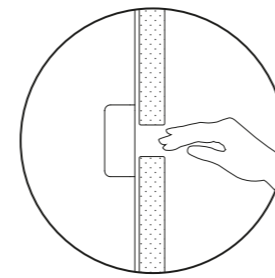

Apertura con gola / Opening with groove



Colonne / Tall units

Abaco della qualità

Ergonomia

L'ergonomia è un concetto guida per Valdesign e si realizza attraverso moduli appositamente studiati e la combinazione degli stessi. Moduli per una progettazione sartoriale dove l'individuo e le sue esigenze sono poste al centro.

ERGONOMICS

Ergonomics is key at Valdesign: units are always carefully planned out and combined together with this concept in mind. Together they create a tailored design, where individual needs are front and centre.

Funzionalità e affidabilità

L'attenzione e cura nei dettagli sono linee guida in ogni parte delle cucine Valdesign. Tutti i cassetti sono forniti di guide in acciaio con una portata collaudata di 40 kg alla coppia per profondità fino a 50 cm e 70 kg alla coppia per profondità 60 cm e movimenti garantiti per 80.000 cicli di apertura e chiusura. Ogni mobile è dotato di ferramenta dei più elevati standard quali cerniere ad innesto rapido con ammortizzatore di chiusura per le ante e guide con chiusura assistita per cassetti e cestoni. Tutto volto a garantire l'affidabilità nel tempo.



FUNCTIONALITY AND AESTHETICS
Care and attention to detail permeate every aspect of Valdesign kitchens. All drawers are supplied with steel runners which are tested to support a load of 40 kg per pair for depths up to 50 cm, and 70 kg per pair for depths of 60 cm. Movement guaranteed for 80,000 opening and closing cycles. Each unit comes with high-quality fixtures and fittings. These include snap-in hinges with assisted closing for the doors and soft-close runners for the drawers. The overarching aim is to ensure our products are reliable over time.

Laccatura e verniciature

Il nostro processo di laccatura prevede la spazzolatura nel caso della finitura lucida in tutte le superfici a vista. Le finiture Fashion wood e Rovere laccato sono realizzate con ciclo di verniciatura all'acqua.

LACQUERING AND PAINTING

Our lacquering process includes brushing to achieve the high-gloss finish for all visible surfaces. The Fashion Wood and lacquered oak finishes are created using water-based paint.

Manutenzione

La durabilità di una cucina si ha attraverso la cura e manutenzione dei suoi elementi. Per questo Valdesign fornisce un set di prodotti per la manutenzione e pulizia volto a preservare ed esaltare le qualità e peculiarità estetiche dei materiali.

MAINTENANCE

Kitchens need to be cared for and maintained to ensure they last. Valdesign provides a maintenance and cleaning kit to protect and enhance the unique look and characteristics of the materials.



Scocche

Tutti i pannelli che utilizziamo per le nostre cucine sono EPA CARB. Tutte le nostre scocche sono idrorepellenti (IDROLEB).

CARCASSES

All the panels we use for our kitchens are EPA CARB certified. All unit carcasses are water-repellent (IDROLEB).



Valdesign®

VALDESIGN srl **cucine**

Via per Sacile 75

31018 Francenigo di Gaiarine

Treviso, Italy

Tel. +39 0434 769811

Fax +39 0434 769845

www.valdesigncucine.it

info@valdesigncucine.it

Verifica le finiture disponibili sul nostro sito internet / Check the finishes available on our website www.valdesigncucine.it

ALF UNO s.p.a. si riserva di apportare in qualsiasi momento modifiche a prodotti, misure e materiali, che ritenesse utili per esigenze di carattere produttivo e commerciale. Per essere sempre aggiornati vi invitiamo a consultare il nostro sito internet www.valdesigncucine.it. LE FINITURE: I materiali utilizzati dalla nostra azienda sono selezionati tra i più affidabili per applicazione e resa estetica. Nonostante questo devono considerarsi tollerabili alcune differenze dovute alle caratteristiche stesse di materiali come essenze naturali, vetri, laccature e all'artigianalità di alcune fasi del processo produttivo che da sempre è un nostro valore aggiunto. Inoltre alcune finiture possono subire nel tempo maturazioni dovute all'azione della luce e del tempo. È importante quindi specificare se nell'ordine vi sono sostituzioni o completamenti per valutare insieme il miglior modo di procedere. Le tonalità di colore e le finiture illustrate vanno considerate puramente indicative. Verificare sempre la fattibilità dell'abbinamento finiture consultando l'interno del listino.

ALF UNO s.p.a. reserves the right to make any changes to products, measurements and materials at any time deemed useful for manufacturing and sales purposes. To stay up to date at all times, please visit our website www.valdesigncucine.it. FINISHES: The materials we use are selected among the most reliable products in terms of application and aesthetic rendering. Despite this, certain differences due to the very characteristics of materials such as natural wood finishes, glass and lacquers must be considered tolerable, as well as the hand-crafted nature of certain phases of the production process, which has always been one of our added values. In addition, some finishes may change over time, due to the effects of light and time. It is therefore important to specify whether there are replacements or completions in the order to assess the best way to proceed together. The finishes featured in this sample collection are purely indicative and are not available for all products. Please check in the price list if the finish is available for the chosen item. Orders will not be accepted for products with finishes not included in the price list. The colour shades and finishes illustrated herein are to be considered purely indicative. Always check the feasibility of finish combinations by consulting the price list contents.

art direction **Bruna Vaccher, Genny Canton** / graphic design **Genny Canton Studio** / digital image **Nudesign** / photo **Riccardo Munarin** / styling **Rosanna Bignucolo, Claudia Barberi** / separations **Luce srl** / print **Sincromia**



Anice



Valdesign[®]
cucine

**Indice
composizioni
Anice
strutturato per
configurazione
ergonomica**

**/
Anice
compositions
organised by
ergonomic
configuration**

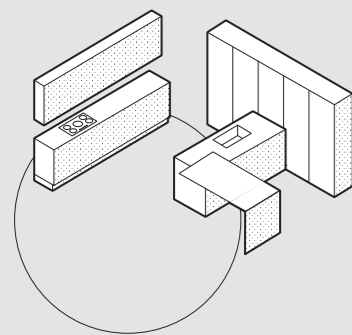

**COMPOSIZIONE A "L"
CON ISOLA E TAVOLO INTEGRATO**
→ L-shaped composition
with island and built-in table

A / 01 → pag. 4

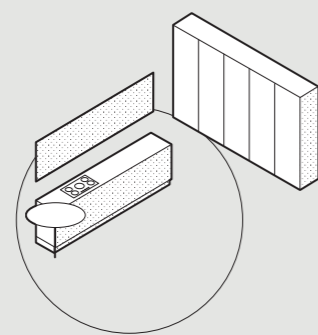

**COMPOSIZIONE LINEARE
CON COLONNE E SNACK INTEGRATO**
→ Linear composition
with tall units and built-in breakfast bar

A / 02 → pag. 16

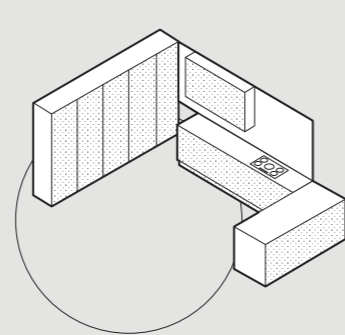

COMPOSIZIONE A "U"
→ U-shaped composition

A / 03 → pag. 24

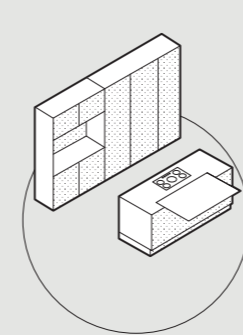

**COMPOSIZIONE COLONNE
CON ISOLA**
→ Tall unit composition
with island

A / 04 → pag. 34

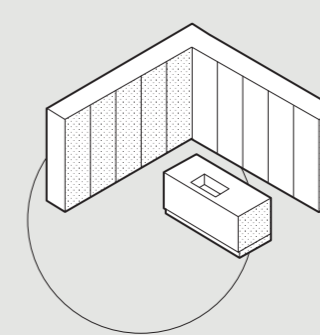

**COMPOSIZIONE A "L"
CON ISOLA**
→ L-shaped composition
with island

A / 05 → pag. 42

comp. **A / 01**

finiture / finishes
Noce Naturale / Natural Walnut
Fenix Grigio efeso











comp. **A / 01**

→ **IT**

Basi Fenix Grigio Efeso
Top e Spalloni Fenix Grigio Efeso
Profilo Anice Verniciato Moka Shine
Zoccolo Laccato opaco Moka Shine

Pensili e boiserie Noce Naturale

Colonne Noce naturale
Vani a giorno Laccato opaco Moka Shine
Zoccolo Laccato opaco Moka Shine

Penisola e piano snack Anice Fenix Grigio efeso
Profilo Anice Verniciato Moka Shine
Zoccolo Laccato opaco Moka Shine

Tavolo **FYRA** e sedia **CORIUM**
 (Per questi articoli vedi **COMPLEMENTI** - Alf DaFrè)

→ **EN**

Base units Fenix Grigio Efeso
Top and large side panels Fenix Grigio Efeso
Anice profile Painted Moka Shine
Plinth Matt Moka Shine lacquer

Wall units and boiserie Natural walnut

Tall units Natural walnut
Open units Matt Moka Shine lacquer
Plinth Matt Moka Shine lacquer

Anice peninsula and breakfast bar Fenix Grigio Efeso
Anice profile Painted Moka Shine
Plinth Matt Moka Shine lacquer

FYRA table and **CORIUM** chair
 (Please see **COMPLEMENTS** - Alf DaFrè for these items)

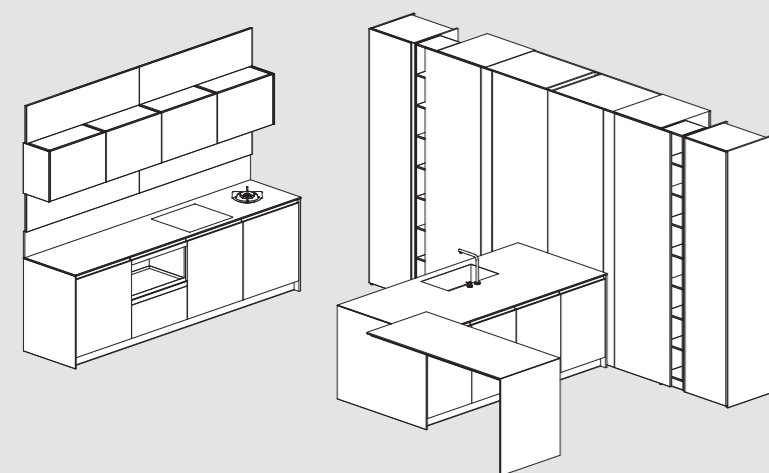

Anice 01

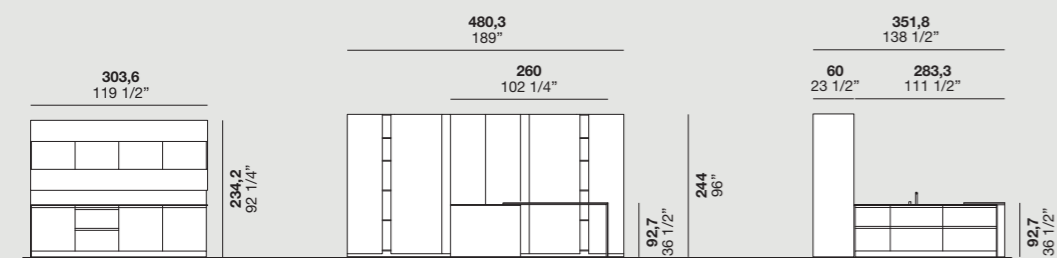

pensili / basi
wall units / base units

colonne
tall units

basi
base units



pensili
tall units

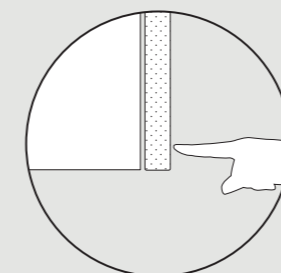

push pull
push-pull opening



basi
base units

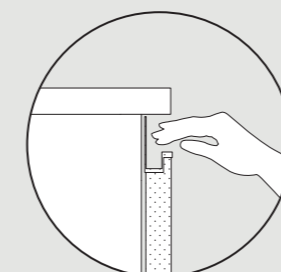

profilo Anice
Anice profile



colonne
tall units

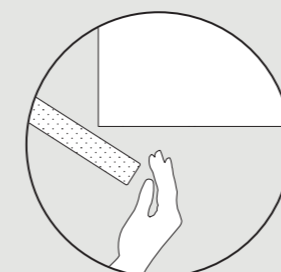

apertura basculante (Colonna Flip)
up-and-over opening (Flip tall units)



comp. A / 02



finiture / finishes
Laccato opaco Piombo / Matt Piombo lacquer
Noce classico / Classic walnut
Laminam Pietra Piasentina / Pietra Piasentina Laminam





comp. **A / 02**

→ **IT**

Basi Laccato opaco Piombo
Profilo Anice Verniciato Moka Shine
Zoccolo Laccato opaco Moka Shine
Top e modulo Brick Laminam Pietra Piasentina

Vani a giorno Noce classico
Boiserie Noce classico
Mensole metallo Metallo Moka Shine
Moduli Flag Moka Stone

Colonne Laccato opaco Piombo
Profilo Anice Verniciato Moka Shine
Zoccolo Laccato opaco Moka Shine

Piano Moon Noce classico
Gamba Laccato opaco Moka Shine

→ **EN**

Base units Matt Piombo lacquer
Anice profile Painted Moka Shine
Plinth Matt Moka Shine lacquer
Top and Brick unit Pietra Piasentina Laminam

Open units Classic walnut
Boiserie Classic walnut
Metal shelves painted Moka Shine
Flag units Moka Stone

Tall units Matt Piombo lacquer
Anice profile Painted Moka Shine
Plinth Matt Moka Shine lacquer
Moon top Classic walnut
Leg Matt Moka Shine lacquer

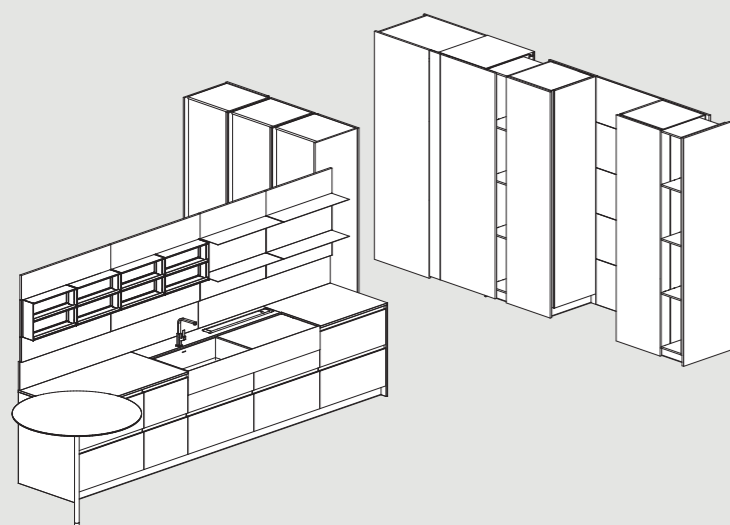

Anice 02

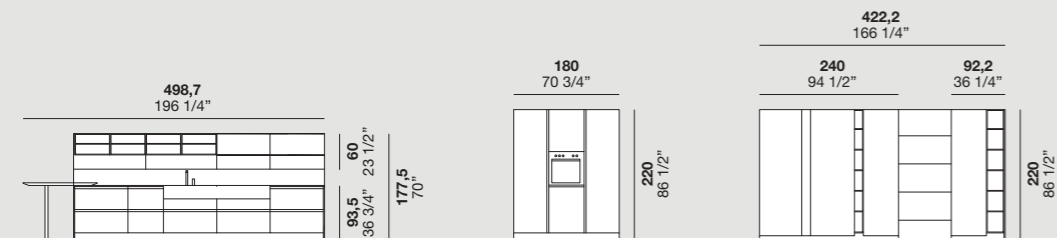

pensili / basi
wall units / base units

colonne
tall units

colonne
tall units

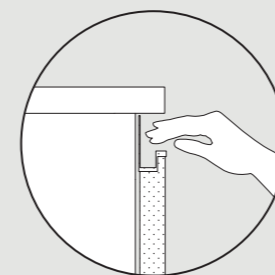

profilo Anice
Anice profile



basi
base units

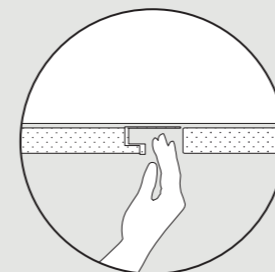

profilo Anice
Anice profile



colonne
tall units

comp. A / 03

finiture / finishes
Fashion wood Rovere Carbone / Carbone oak Fashion Wood
Laminam Calce nero
Nobilitato Old brass / Old Brass surface









comp. **A / 03**

→ IT

Basi Fashion wood rovere
Carbone
Vani a giorno Fashion wood
rovere Carbone
Profilo Anice Verniciato
Nichel SG
Zoccolo Laccato micalizzato
Nichel SG
Top e Spalloni Calce Nero

Moduli Flag Moka Stone
Pensili Nobilitato Old brass
Boiserie Fashion wood rovere
Carbone

Mensole Metallo Moka Shine
Colonne Nobilitato Old brass
Vano a giorno Fashion wood
rovere Carbone
Profilo Anice Verniciato
Nichel SG
Zoccolo Laccato micalizzato
Nichel SG

→ EN

Base units Carbone oak
Fashion Wood
Open units Carbone oak
Fashion Wood
Anice profile Painted Nichel SG
Plinth Micalised Nichel SG
lacquer
Top and large side panels
Calce Nero

Flag units Moka Stone
Wall units Old Brass surface
Boiserie Carbone oak Fashion
Wood

Shelves Moka Shine metal
Tall units Old Brass surface
Open compartment Carbone
oak Fashion Wood
Anice profile Painted Nichel SG
Plinth Micalised Nichel SG
lacquer

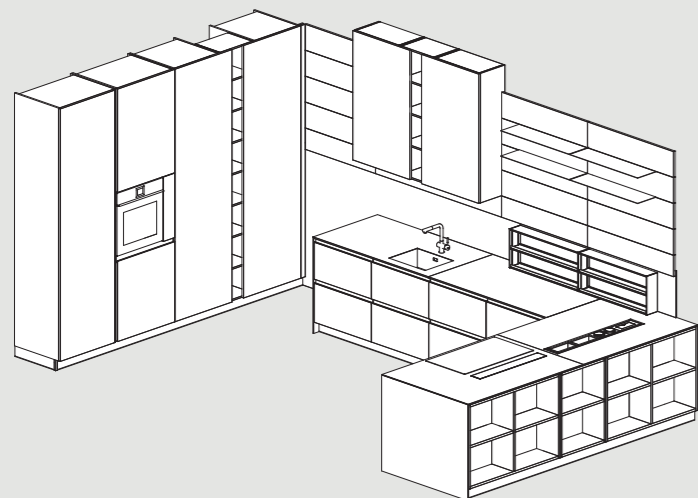

Anice 03

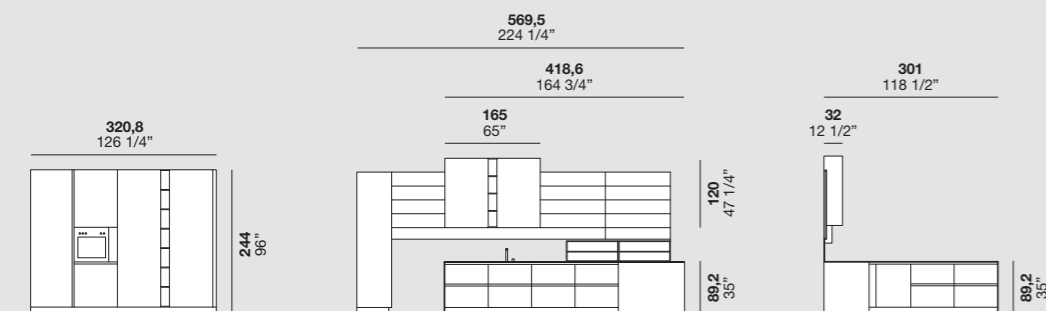

colonne
tall units

pensili / basi
wall units / base units

basi
base units

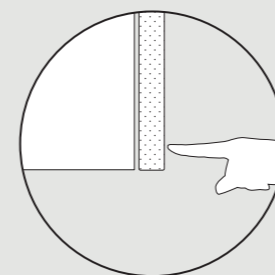

push pull
Push-pull opening



pensili
tall units

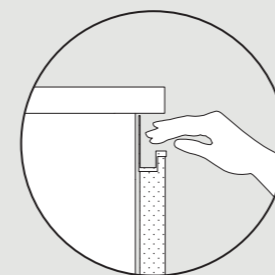

profilo Anice
Anice profile



basi
base units

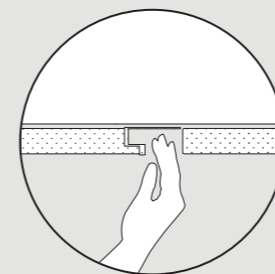

profilo Anice
Anice profile



colonne
tall units



finiture / finishes
Nobilitato Rasato Fumè / Fumé stucco-look surface
Fashion wood rovere Carbone / Carbone oak Fashion Wood
Laccato opaco Neve / Matt Neve lacquer
Acciaio / Steel





comp. **A / 04**

→ **IT**

Isola Nobilitato Rasato Fumè
Profilo Anice Verniciato Moka Shine

Zoccolo Laccato opaco Moka Shine

Top Acciaio

Piano Shift Fashion wood rovere Carbone

Colonne Laccato opaco Neve

Pannelli nicchia Laccato opaco Nero

Profilo Anice Verniciato Moka Shine

Zoccolo Laccato opaco Moka Shine

Top Acciaio

Moduli Flag Moka Stone

Boiserie Nobilitato Rasato Fumè

Mensole metallo Moka Shine

Libreria **ANTIS** (Per questo articolo vedi DAY COLLECTION / ANTIS - Alf DaFrè)

Tall units Matt Neve lacquer

Niche panels Matt Nero lacquer

Anice profile Painted Moka Shine

Anice profile Painted Moka Shine

→ **EN**

Island Fumé stucco-look surface

Anice profile Painted Moka Shine

Plinth Matt Moka Shine lacquer

Top Steel

Shift top Carbone oak Fashion Wood

Plinth Matt Moka Shine lacquer

Top Steel

Flag units Moka Stone

Boiserie Fumé stucco-look surface

Shelves Moka Shine metal

ANTIS bookcase (Please see DAY COLLECTION / ANTIS - Alf DaFrè for this item)

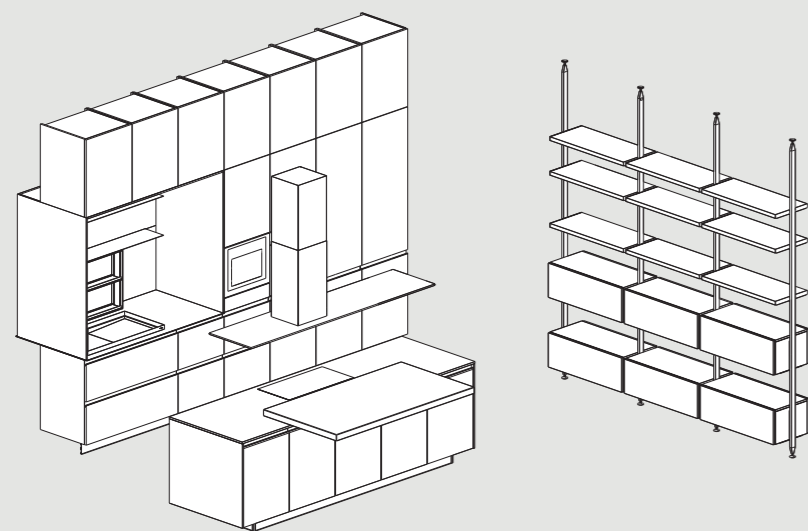

Anice 04

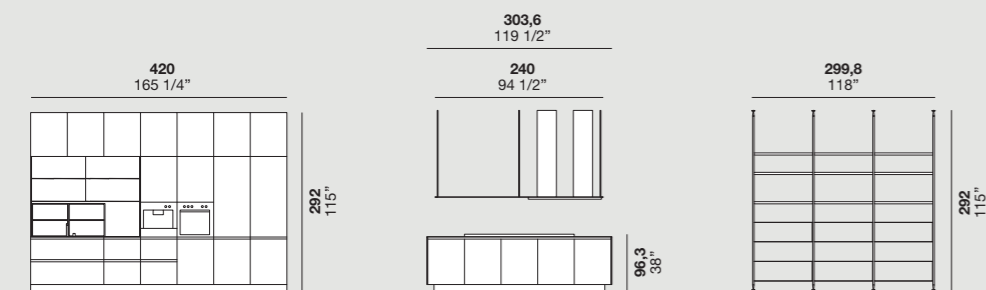

pensili / basi
wall units / base units

basi
base units

colonne
tall units

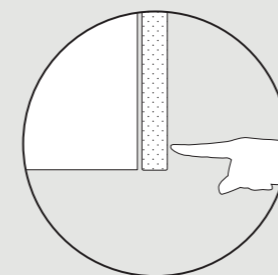

push pull
Push-pull opening



pensili
tall units

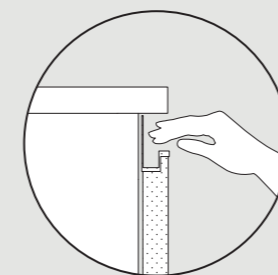

profilo Anice
Anice profile

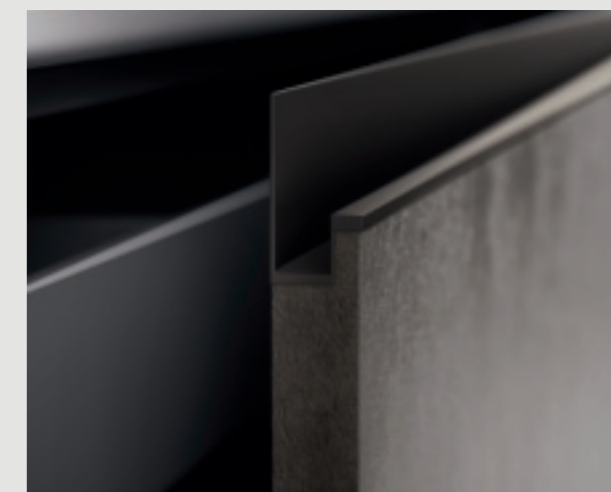

basi
base units

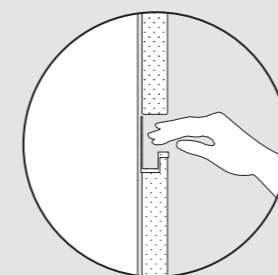

profilo Anice
Anice profile



colonne
tall units

comp. A / 05



finiture / finishes
Laccato opaco Arena / Matt Arena lacquer
Laminam Ossido nero / Nero Ossido Laminam
Olmo Chiaro / Chiaro Elm







comp. **A / 05**

→ IT

Isola Laccato opaco Arena
Top Laminam Ossido nero
Vano a giorno Laccato opaco Arena
Profilo Anice Verniciato Moka Shine
Zoccolo Laccato opaco Moka Shine

Colonne e Vani a giorno
 Laccato opaco Arena
Profilo Anice Verniciato Moka Shine
Zoccolo Laccato opaco Moka Shine

Colonne Canvas anta vetro trasparente grigio, telaio Moka Shine
Scocca Laccato opaco Arena
Schiena Olmo Chiaro

Scocca Laccato opaco Arena
Schiena Olmo Chiaro

→ EN

Island Matt Arena lacquer
Top Nero Ossido Laminam
Open compartment Matt Arena lacquer
Anice profile Painted Moka Shine
Plinth Matt Moka Shine lacquer

Tall units and open compartments Matt Arena lacquer
Anice profile Painted Moka Shine

Plinth Matt Moka Shine lacquer
Canvas tall units Grigio transparent glass door, Moka Shine frame
Body Matt Arena lacquer
Back panel Chiaro elm

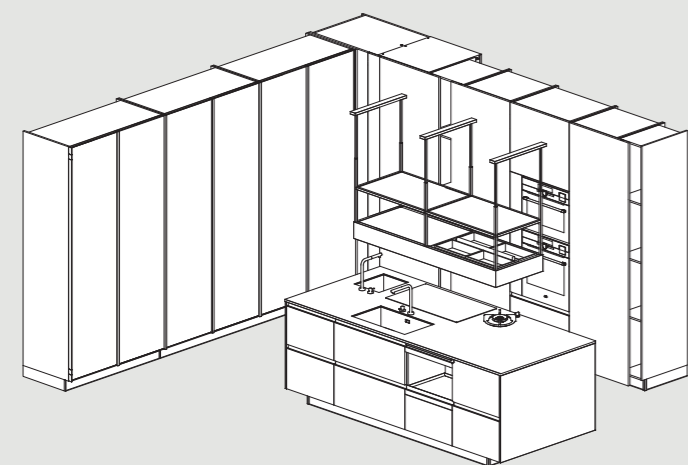

Anice 05

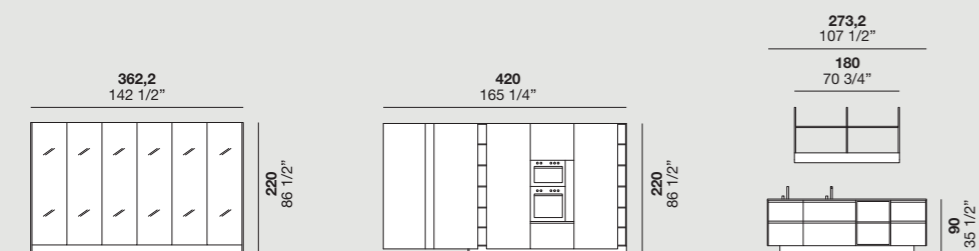

colonne tall units

colonne tall units

basi base units

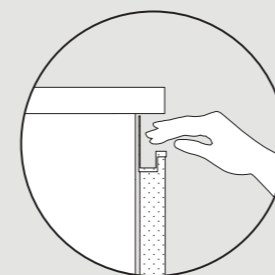

profilo Anice
Anice profile



basi
base units

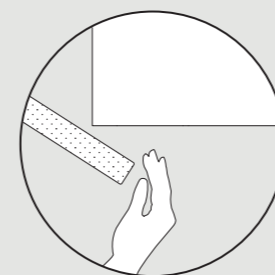

apertura basculante (Colonna Flip)
up-and-over opening (Flip tall units)



colonne tall units

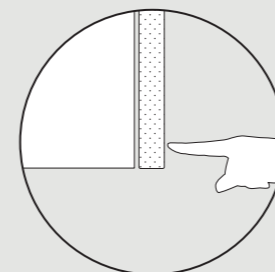

push pull
Push-pull opening



colonne tall units

**Sistema
Brick
/
Brick
System**



Valdesign presenta
**Brick. Il nuovo sistema di
piani in appoggio a basi
H. 60,8 cm, disponibile
nelle seguenti tipologie:
Brick vasca, Brick piano
cottura, Brick vasca +
piano.**

Valdesign presents Brick
The new system of tops
stacked on base units
measuring H. 60.8 cm
comes in the following
types: Sink Brick, Hob Brick,
Sink + Hob Brick.

1 / Brick vasca + piano cottura
Sink + Hob Brick

2 / Brick neutro
Plain Brick

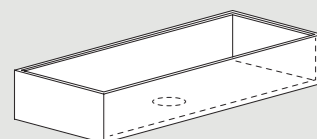

Brick vasca
Sink Brick

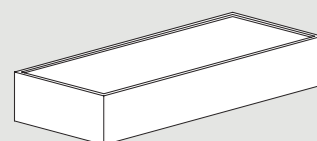

Brick piano cottura
Hob Brick

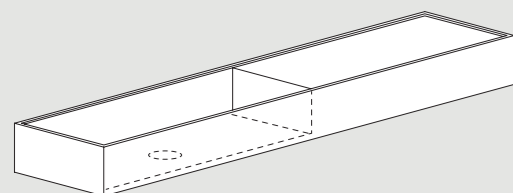

Brick vasca + piano cottura
Sink + Hob Brick



Esempi di composizioni Brick / Brick composition examples

→ **IT**
 Gli elementi Brick hanno altezza di 23,3 cm (Laminam) e di 24,3 cm (Marmo, Granito) e vanno posizionati sopra a basi specifiche di altezza 60,8 cm con un cassetto e un cestone.

→ **EN**
 Brick modules measure H. 23.3 cm (Laminam) and 24.3 cm (Marble, Granite) and are stacked on specific base units measuring 60.8 cm with different depth drawers.

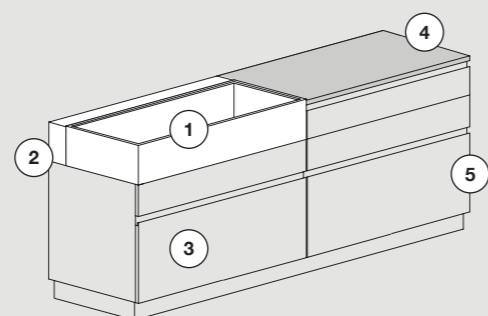
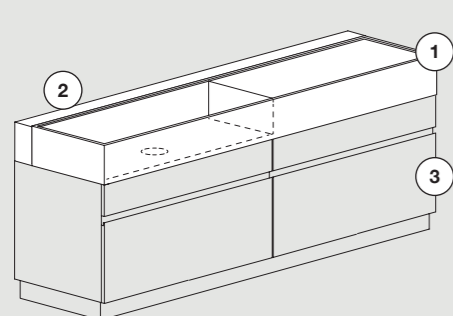

1 / Brick vasca + piano cottura
 Sink + Hob Brick

2 / Brick neutro
 Plain Brick

3 / Nuova base H 60,8 cm
 New base unit H. 60.8 cm

1 / Brick vasca
 Sink Brick

2 / Brick neutro
 Plain Brick

3 / Nuova base H 60,8 cm
 New base unit H. 60.8 cm

4 / Piano Sp. 2 cm
 Top 2 cm thick

5 / Base H 81,5 cm
 Base unit H 81.5 cm

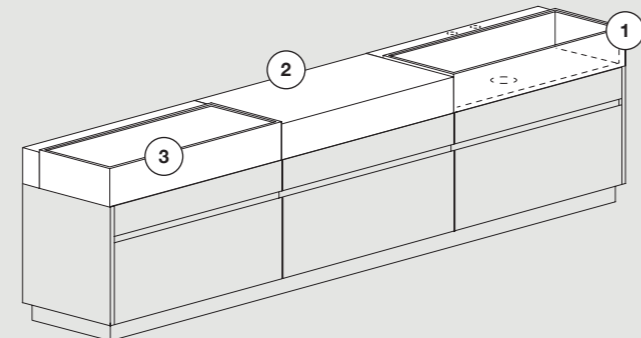
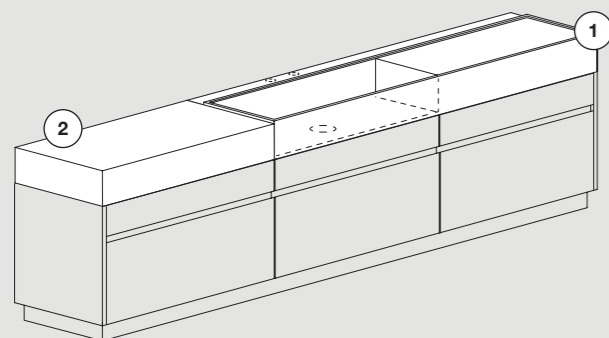

COMPOSIZIONI A MURO
 → Wall composition

1 / Brick vasca + piano cottura
 Sink + Hob Brick

2 / Brick neutro
 Plain Brick

1 / Brick vasca
 Sink Brick

2 / Brick neutro
 Plain Brick

3 / Brick piano cottura
 Hob Brick

→ **IT**
 Gli elementi Brick vasca o piano cottura vengono abbinati a Brick "neutri". I Brick neutri fungono da elementi di compensazione in cui possono essere inseriti i fori per miscelatore. Permettono inoltre di creare composizioni isola.

→ **EN**
 Sink Brick and Hob Brick modules are paired with plain Brick modules. Plain Brick modules act as compensation and can be drilled with a holes for a mixer tap. They can also be used to create an island composition.

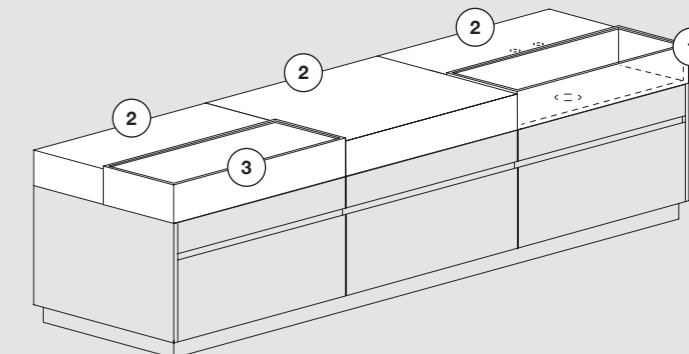
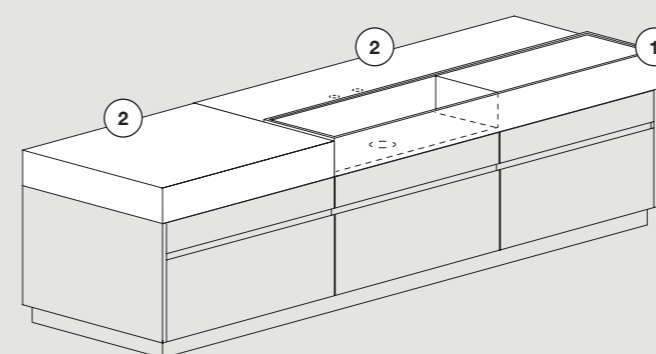

COMPOSIZIONI ISOLA
 → Island compositions

1 / Brick vasca + piano cottura
 Sink + Hob Brick

2 / Brick neutro
 Plain Brick

1 / Brick vasca
 Sink Brick

2 / Brick neutro
 Plain Brick

3 / Brick piano cottura
 Hob Brick

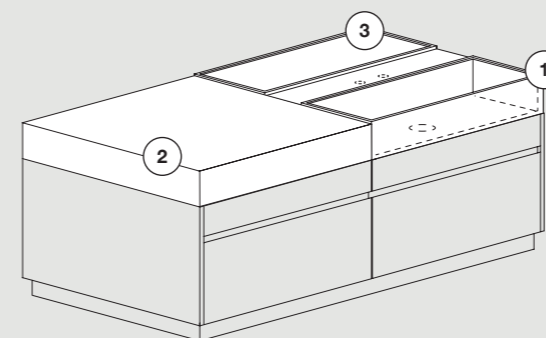

1 / Brick vasca
 Sink Brick

2 / Brick neutro
 Plain Brick

3 / Brick piano cottura
 Hob Brick

Plus
prodotto
/
Product
strengths

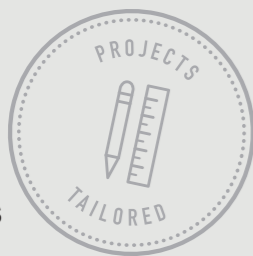

→ **IT / LACCATURA**
Il nostro processo di laccatura prevede la spazzolatura nel caso della finitura lucida in tutte le superfici a vista.

→ **EN / LACQUERING**
Our lacquering process includes brushing to achieve the high-gloss finish for all visible surfaces.

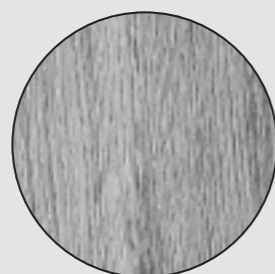

→ **IT / CICLO DI VERNICIATURA**
Le finiture Fashion wood e Rovere laccato sono realizzate con ciclo di verniciatura all'acqua.

→ **EN / PAINTING**
The Fashion Wood and lacquered oak finishes are created using water-based paint.



→ **IT / SCOCHE**
Le nostre scocche sono idrorepellenti **IDROLEB**.

→ **EN / BODIES**
The unit bodies are water-repellent (**IDROLEB**).



→ **IT / SCOCHE**
Le nostre scocche sono a bassa emissione di formaldeide secondo normative **EPA** e **CARB**.

→ **EN / BODIES**
Our unit bodies have low formaldehyde emissions according to the **EPA** and **CARB** regulations.

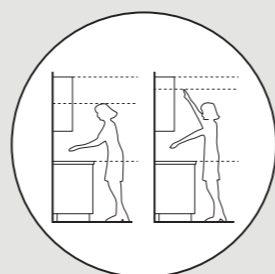

→ **IT / ERGONOMIA**
Grazie alla vasta modularità è sempre possibile realizzare l'ergonomia perfetta.

→ **EN / ERGONOMICS**
Thanks to the vast array of modular units, you can create the perfect ergonomic set-up every time.



→ **IT / GUIDE**
I nostri cassetti sono forniti di guide in acciaio con portata collaudata di 40 kg alla coppia per profondità fino a 50 cm e 70 kg alla coppia per profondità 60 cm e movimenti garantiti per 80.000 cicli di apertura e chiusura.

→ **EN / RUNNERS**
Drawers are supplied with steel runners, which are tested to support a load of 40 kg per pair for depths up to 50 cm, and 70 kg per pair for depths of 60 cm. Movement guaranteed for 80,000 opening and closing cycles.



→ **IT / FERRAMENTA**
Ogni mobile è fornito di ferramenta per garantire l'affidabilità nel tempo quali cerniere ad innesto rapido con ammortizzatore di chiusura per le ante e guide con chiusura assistita per cassetti e cestoni.

→ **EN / HARDWARE**
Each unit comes with fixtures and fittings to ensure long-lasting reliability. These include snap-in hinges with assisted closing for the doors and soft-close runners for the drawers.

art direction
Brunella Vaccher
Genny Canton

set coordinator/graphic
Genny Canton Studio

digital image
Nudesign

separations
Lucegroup

print
Sincromia

stampato
Maggio 2022



Valdesign®

cucine

VALDESIGN srl
Via per Sacile 75
31018 Francenigo di Gaiarine
Treviso, Italy
Tel. +39 0434 769811
Fax +39 0434 769845
www.valdesigncucine.it
info@valdesigncucine.it

Verifica le finiture disponibili sul nostro sito internet. / Check the finishes available on our website. / Consulte los acabados disponibles en nuestro sitio web. / Vérifiez les finitions disponibles sur notre site internet. / Überprüfen Sie auf unserer Webseite, ob die gewünschte Ausführung erhältlich ist. / Познакомьтесь с вариантами отделки на нашем интернет-сайте **www.valdesigncucine.it**

ALF UNO s.p.a. si riserva di apportare in qualsiasi momento modifiche a prodotti, misure e materiali, che ritenesse utili per esigenze di carattere produttivo e commerciale. Per essere sempre aggiornati vi invitiamo a consultare il nostro sito internet **www.valdesigncucine.it**

LE FINITURE

I materiali utilizzati dalla nostra azienda sono selezionati tra i più affidabili per applicazione e resa estetica. Nonostante questo devono considerarsi tollerabili alcune differenze dovute alle caratteristiche stesse di materiali come essenze naturali, vetri, laccature e all'artigianalità di alcune fasi del processo produttivo che da sempre è un nostro valore aggiunto. Inoltre alcune finiture possono subire nel tempo maturazioni dovute all'azione della luce e del tempo. È importante quindi specificare se nell'ordine vi sono sostituzioni o completamenti per valutare insieme il miglior modo di procedere. Le tonalità di colore e le finiture illustrate vanno considerate puramente indicative. Verificare sempre la fattibilità dell'abbinamento finiture consultando l'interno del listino.

ALF UNO s.p.a. reserves the right to make any changes to products, measurements and materials at any time deemed useful for manufacturing and sales purposes. To stay up to date at all times, please visit our website **www.valdesigncucine.it**

FINISHES

The materials we use are selected among the most reliable products in terms of application and aesthetic rendering. Despite this, certain differences due to the very characteristics of materials such as natural wood finishes, glass and lacquers must be considered tolerable, as well as the hand-crafted nature of certain phases of the production process, which has always been one of our added values. In addition, some finishes may change over time, due to the effects of light and time. It is therefore important to specify whether there are replacements or completions in the order to assess the best way to proceed together. The finishes featured in this sample collection are purely indicative and are not available for all products. Please check in the price list if the finish is available for the chosen item. Orders will not be accepted for products with finishes not included in the price list. The colour shades and finishes illustrated herein are to be considered purely indicative. Always check the feasibility of finish combinations by consulting the price list contents.

LA CUCINA NASCOSTA / THE HIDDEN KITCHEN



**LA CUCINA NASCOSTA
/ THE HIDDEN KITCHEN**

La cucina nascosta

La cucina nascosta si integra negli spazi fino a fondersi con le architetture, combinando modularità e libertà progettuale grazie alle infinite configurazioni di finiture e dettagli. Che sia il minimalismo estetico di *Sesamo*, con l'elegante apertura ad un solo movimento, o la versatilità del sistema *Ante rientranti*, in grado di assolvere molteplici funzioni, la cucina nascosta dà vita a possibilità progettuali sempre diverse, in armonia con l'ambiente circostante.

The hidden kitchen becomes part of the space, merging with the architecture, and combining a modular build with a freedom to create in an infinite array of finishes and details. SESAMO offers aesthetic minimalism, with its elegant single-movement opening, while the POCKET-DOOR mechanism provides versatility, performing many functions: the hidden kitchen allows you to keep changing your interior design to suit the surroundings.





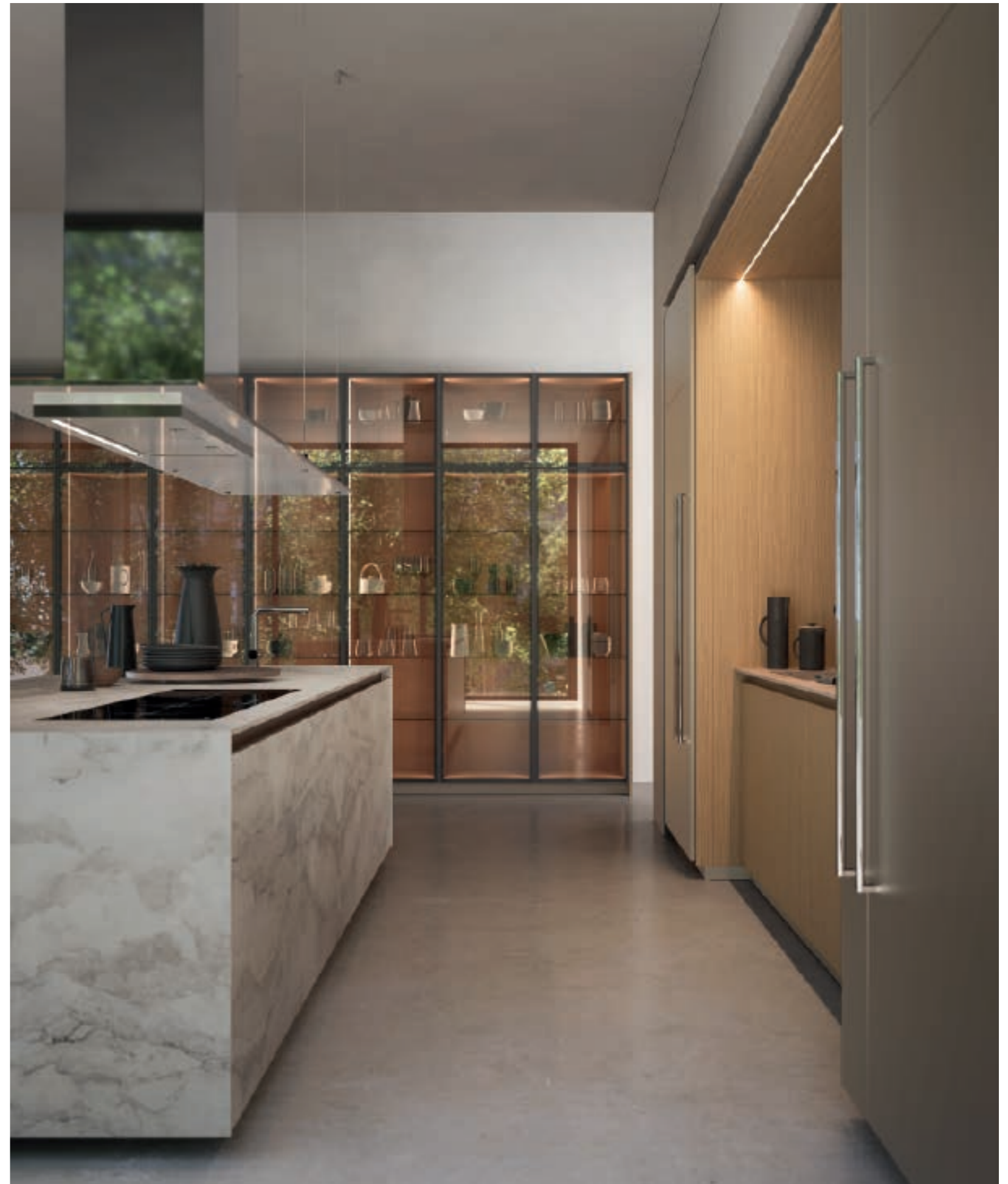





L'anta rientrate ha un movimento di inserimento ed estrazione assistita che permette un fluido scorrimento e al tempo stesso nasconde i moduli funzionali. Nella foto il modulo forno più micro. / The pocket doors have an assisted insertion and extraction motion, meaning they slide smoothly, while concealing practical units behind. Oven and microwave unit shown in the image.



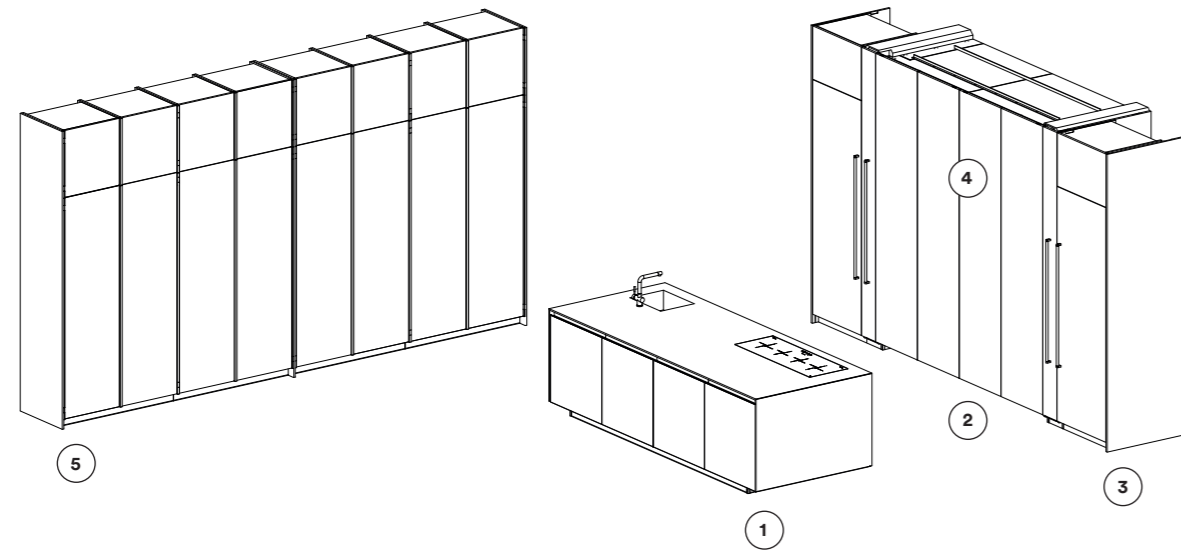

1 BASI ISOLA / ISLAND BASE UNITS
Basi Zafferano e top Pietra Luxury Camouflage, gola e zoccolo Moka shine./ Zafferano Island base units and top Camouflage Luxury stone, groove and plinth Moka shine.

2 COLONNE SESAMO / SESAMO TALL UNITS
Colonne Sesamo laccato micalizzato Nickel, maniglia C60 Nickel satinato, interno Fashion wood rovere Naturale, Top e schienale Pietra Luxury Camouflage, gola Fashion wood rovere Naturale e zoccolo Nickel, Mensole metallo Moka shine./ Sesamo tall units Micalised Nickel lacquer, C60 brushed Nickel handle, Fashion wood rovere Naturale oak interior, Top and back in Camouflage Luxury stone, Fashion wood rovere Naturale oak groove and Nickel plinth, Metal shelves Moka shine.

3 COLONNE / TALL UNITS
Colonne con ante rientranti laccato micalizzato Nickel, maniglia C60 Nickel satinato, interno antracite e zoccolo Nickel./ Tall units with pocket doors Micalised Nickel lacquer, C60 brushed Nickel handle, antracite interior and Nickel plinth.

4 MODULI FLAG / FLAG UNITS
Moduli Flag moka stone. / Flag units Moka stone.

5 COLONNE CANVAS / CANVAS TALL UNITS
Colonne Canvas anta vetro trasparente grigio, telaio Moka shine, scocca e schiena Fashion wood rovere Naturale./ Canvas tall units Grigio transparent glass door, Moka shine frame, body and back panel Fashion wood Naturale oak.

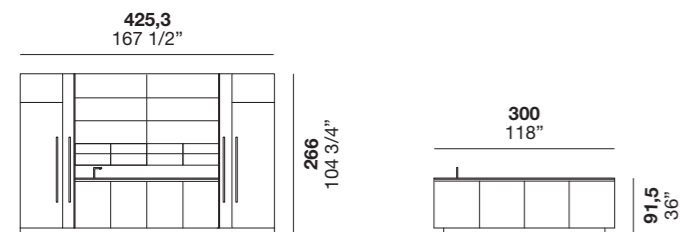

Colonne Sesamo / Tall units Sesamo

Isola / Island

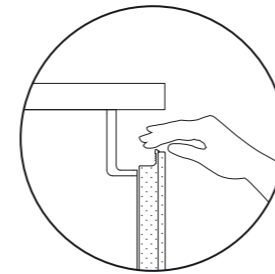

Apertura con gola curva, telaio Zafferano / Opening with curved groove, Zafferano frame

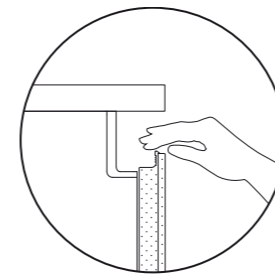

Apertura con gola curva, telaio Zafferano / Opening with curved groove, Zafferano frame

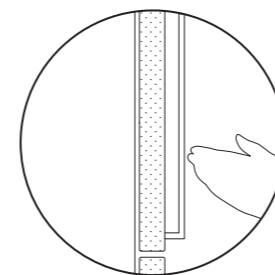

Apertura con maniglia / Opening with handle



Basi / Base units



Isola / Island



Colonne / Tall units

Sesamo

Come una quinta teatrale, con un solo movimento fluido e morbido, Sesamo si apre alla progettualità e al tempo stesso nasconde al suo interno tutte le funzionalità di una cucina completa. La fascia di copertura è un sipario che rende elegante la cucina sia quando è aperta, sia quando è chiusa. Sullo sfondo un palco in cui la libertà di configurazione degli elementi la fa da protagonista, con l'illuminazione a led ad arricchirne l'atmosfera. Un solo movimento che scopre all'interno molto più di una cucina: un nuovo concetto di abitare e vivere lo spazio.

Like the curtains of a theatre stage, Sesamo opens up with one smooth, fluid movement, to new designs. Behind, it hides all the practical features of a fully functional kitchen. The cover panel dresses the kitchen, giving it an elegant look both when open and closed. The freely configurable unit behind takes centre stage, with LED lighting to create atmosphere. One simple movement to part the stage curtains reveals much more than a kitchen: it unveils a new concept of living and a new way of experiencing the space.







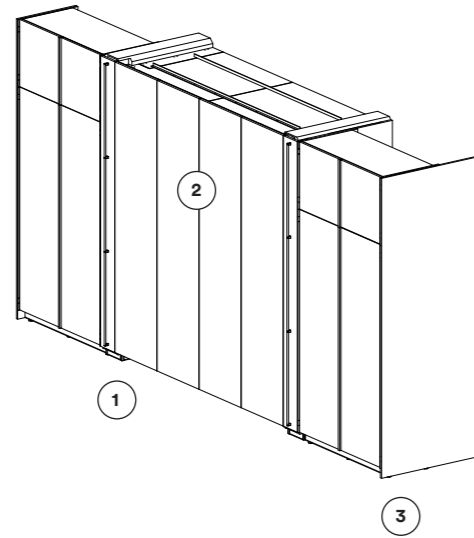

1 COLONNE SESAMO / SESAMO TALL UNITS
 Colonne Sesamo Fashion wood Rovere Carbone, Maniglia C70 Antracite, Basi e pensili laccato opaco Fango, Top e schienale Laminam Fokos Roccia, zoccolo Moka shine. / Sesamo tall units Fashion wood Carbone oak, C70 Antracite handle, Top and back in Laminam Fokos Roccia, Moka shine plinth.

2 MODULI FLAG / FLAG UNITS
 Moduli Flag moka stone. / Flag units Moka stone.

3 COLONNE CANVAS / CANVAS TALL UNITS
 Colonne Canvas anta vetro trasparente grigio, telaio Moka shine, scocca e schiena Fashion wood rovere Carbone. / Canvas tall units Grigio transparent glass door, Moka shine frame, body and back panel Fashion wood Carbone oak.

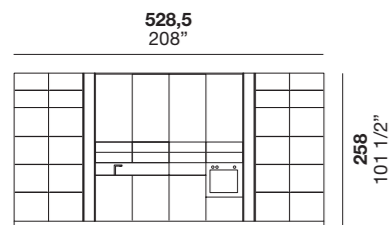

Colonne Sesamo e Ante rientranti / Sesamo tall units with pocket doors

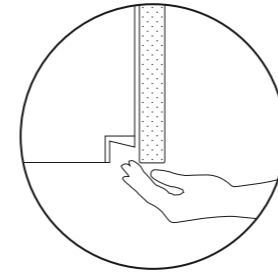

Apertura con gola / Opening with groove

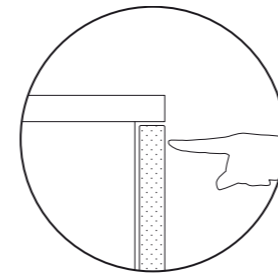

Apertura push pull / Opening with push pull

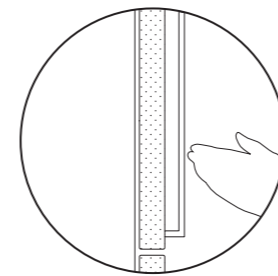

Apertura con maniglia / Opening with handle

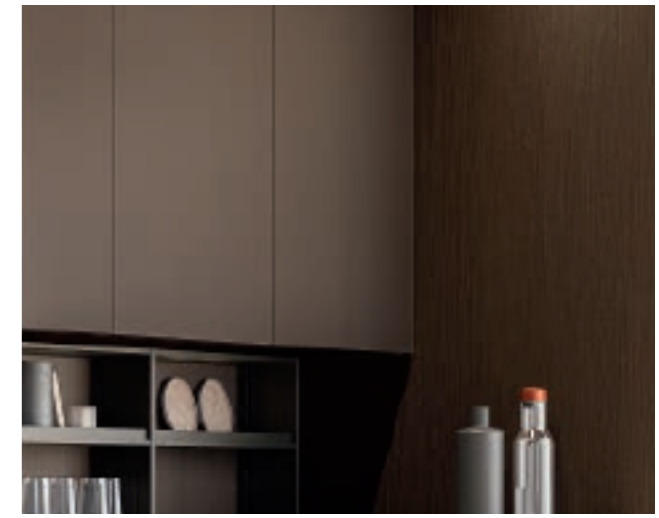

Pensili / Wall units



Basi / Base units

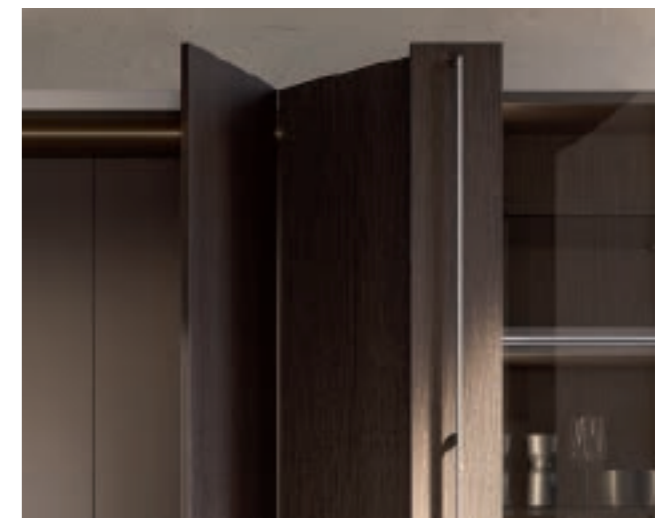

Colonne / Tall units

Ante rientranti

L'anta rientrante fonde pulizia estetica e modularità. Una colonna a una o due ante attrezzabile liberamente in base alle necessità progettuali. L'anta a scomparsa con movimenti di rientro ammortizzato nasconde al suo interno molteplici configurazioni, dalla cucina alla lavanderia. Moduli affiancabili tra loro per creare un sistema che interpreti al meglio lo spazio e le esigenze di chi lo abita.

Pocket doors combine sleek aesthetics with a modular design. A tall unit with one or two doors can be equipped to suit your design requirements. The concealed pocket doors with soft close can be used to conceal multiple configurations, from kitchen units to laundry units. These units can be used side by side, to create the perfect composition for your space and needs.









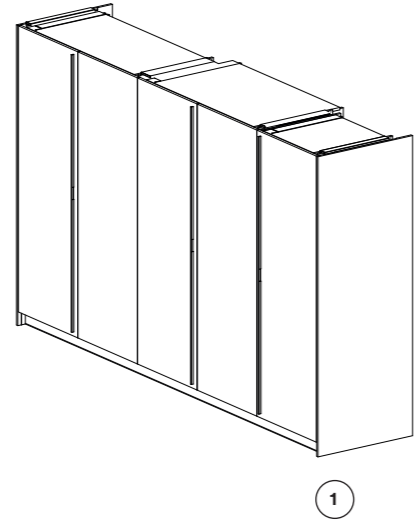

1 COLONNE / TALL UNIS
 Colonne con ante rientranti Noce Naturale, maniglia MZ e zoccolo Moka shine, Top e schienale Acciaio satinato, gola Moka shine, Cassetti Antracite. / Tall units with pocket doors in Naturale walnut, MZ handle and plinth Moka shine, Top and back in satin steel, groove Moka shine, Antracite drawers.

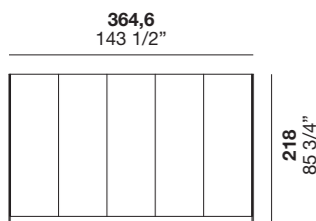

Colonne Ante rientranti / Tall units with pocket doors

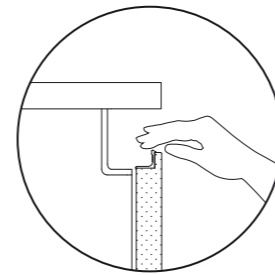

Apertura con gola curva, profilo L90 / Opening with curved groove, L90 profile



Basi / Base units

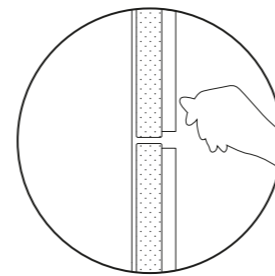

Apertura con maniglia / Opening with handle



Colonne / Tall units







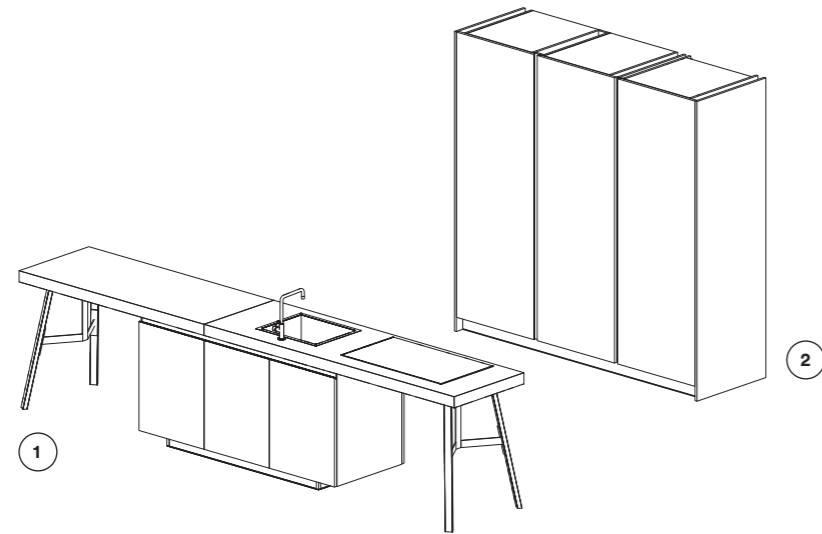

1 BASI / BASE UNITS
 Basi laccato opaco Bianco, gola e profilo "L40" laccato opaco Bianco, zoccolo laccato opaco Bianco, top Fenix Bianco Kos, gamba penisola "Titan" Moka Shine.

/ Matt lacquered Bianco base units, matt lacquered Bianco groove and "L40" profile matt lacquered Bianco plinth, Fenix Bianco Kos top, Moka Shine "Titan" peninsula leg.

2 COLONNE / TALL UNITS
 Colonne con ante rientranti Laccato opaco Platino, gola laccato opaco Platino, profilo "L40" Moka Shine. / Matt lacquered Platino tall units with pocket doors, matt lacquered Platino groove, Moka Shine "L40" profile.

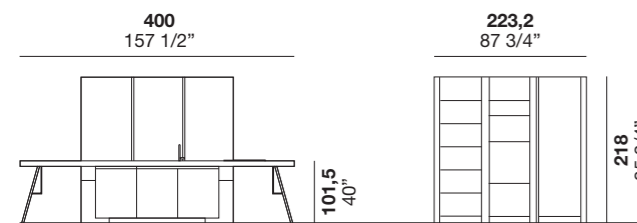

Bar snack / Breakfast bar base unit

Colonne ante rientranti / Tall units with pocket doors

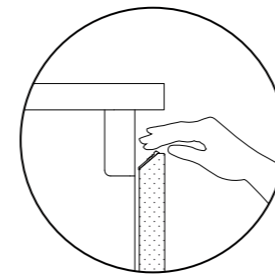

Apertura con gola piatta, profilo L40 / Opening with flat groove and L40 profile



Basi / Base units

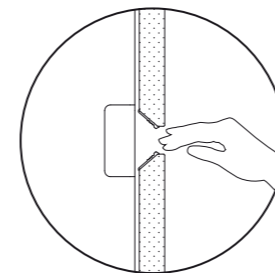

Apertura con gola piatta, profilo L40 / Opening with flat groove and L40 profile



Colonne / Tall units





BASI / BASE UNITS

Basi nobilitato Noce, gola Moka Shine, profilo "L90" e zoccolo Moka shine, top Laminam Fokos Sale. / Surfaced Walnut base units, Moka shine groove, "L90" profile and plinth, Laminam Fokos Sale top.

PENSILI / WALL UNITS

Pensili nobilitato Metal bronze. / Surfaced Metal bronze wall units.

COLONNE / TALL UNITS

Colonne con ante rientranti nobilitato Metal bronze, interno Antracite Maniglia P42 e zoccolo Moka shine. / Surfaced Metal bronze wall units with pocket doors Antracite body Moka shine P42 handle and plinth.

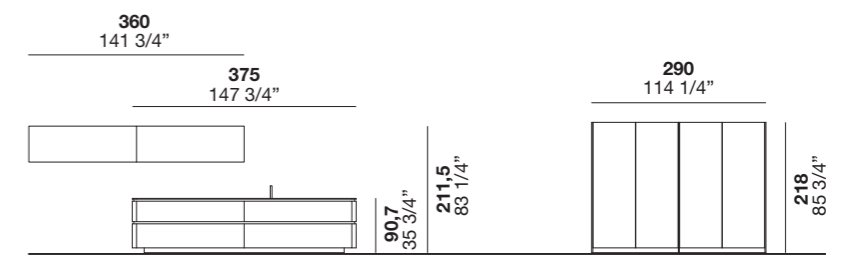

Pensili, basi / Wall units, base units

Colonne / Tall units



718,1
282 3/4"

218
85 3/4"

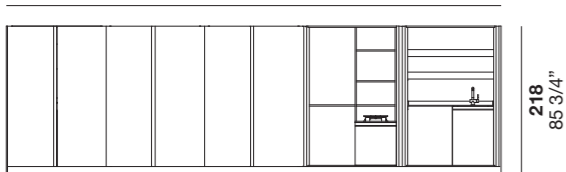

COLONNE / TALL UNITS

Colonne con ante rientranti laccato opaco Platino, interno Antracite Piano Corian Glacier white, maniglia MZ e zoccolo Moka Shine. / Matt lacquered Platino wall units with pocket doors, Antracite body Corian Glacier white top, Moka shine MZ handle and plinth.

Colonne / Tall units

Abaco della qualità

Ergonomia

L'ergonomia è un concetto guida per Valdesign e si realizza attraverso moduli appositamente studiati e la combinazione degli stessi. Moduli per una progettazione sartoriale dove l'individuo e le sue esigenze sono poste al centro.

ERGONOMICS

Ergonomics is key at Valdesign: units are always carefully planned out and combined together with this concept in mind. Together they create a tailored design, where individual needs are front and centre.

Funzionalità e affidabilità

L'attenzione e cura nei dettagli sono linee guida in ogni parte delle cucine Valdesign. Tutti i cassetti sono forniti di guide in acciaio con una portata collaudata di 40 kg alla coppia per profondità fino a 50 cm e 70 kg alla coppia per profondità 60 cm e movimenti garantiti per 80.000 cicli di apertura e chiusura. Ogni mobile è dotato di ferramenta dei più elevati standard quali cerniere ad innesto rapido con ammortizzatore di chiusura per le ante e guide con chiusura assistita per cassetti e cestoni. Tutto volto a garantire l'affidabilità nel tempo.

FUNCTIONALITY AND AESTHETICS
Care and attention to detail permeate every aspect of Valdesign kitchens. All drawers are supplied with steel runners which are tested to support a load of 40 kg per pair for depths up to 50 cm, and 70 kg per pair for depths of 60 cm. Movement guaranteed for 80,000 opening and closing cycles. Each unit comes with high-quality fixtures and fittings. These include snap-in hinges with assisted closing for the doors and soft-close runners for the drawers. The overarching aim is to ensure our products are reliable over time.



Laccatura e verniciature

Il nostro processo di laccatura prevede la spazzolatura nel caso della finitura lucida in tutte le superfici a vista. Le finiture Fashion wood e Rovere laccato sono realizzate con ciclo di verniciatura all'acqua.

LACQUERING AND PAINTING
Our lacquering process includes brushing to achieve the high-gloss finish for all visible surfaces. The Fashion Wood and lacquered oak finishes are created using water-based paint.

Manutenzione

La durabilità di una cucina si ha attraverso la cura e manutenzione dei suoi elementi. Per questo Valdesign fornisce un set di prodotti per la manutenzione e pulizia volto a preservare ed esaltare le qualità e peculiarità estetiche dei materiali.

MAINTENANCE

Kitchens need to be cared for and maintained to ensure they last. Valdesign provides a maintenance and cleaning kit to protect and enhance the unique look and characteristics of the materials.



Scocche

Tutti i pannelli che utilizziamo per le nostre cucine sono EPA CARB. Tutte le nostre scocche sono idrorepellenti (IDROLEB).

CARCASSES

All the panels we use for our kitchens are EPA CARB certified. All unit bodies are water-repellent (IDROLEB).



Valdesign®

VALDESIGN srl **cucine**
Via per Sacile 75
31018 Francenigo di Gaiarine
Treviso, Italy
Tel. +39 0434 769811
Fax +39 0434 769845
www.valdesigncucine.it
info@valdesigncucine.it

Verifica le finiture disponibili sul nostro sito internet / Check the finishes available on our website www.valdesigncucine.it

ALF UNO s.p.a. si riserva di apportare in qualsiasi momento modifiche a prodotti, misure e materiali, che ritenesse utili per esigenze di carattere produttivo e commerciale. Per essere sempre aggiornati vi invitiamo a consultare il nostro sito internet www.valdesigncucine.it. LE FINITURE: I materiali utilizzati dalla nostra azienda sono selezionati tra i più affidabili per applicazione e resa estetica. Nonostante questo devono considerarsi tollerabili alcune differenze dovute alle caratteristiche stesse di materiali come essenze naturali, vetri, laccature e all'artigianalità di alcune fasi del processo produttivo che da sempre è un nostro valore aggiunto. Inoltre alcune finiture possono subire nel tempo maturazioni dovute all'azione della luce e del tempo. È importante quindi specificare se nell'ordine vi sono sostituzioni o completamenti per valutare insieme il miglior modo di procedere. Le tonalità di colore e le finiture illustrate vanno considerate puramente indicative. Verificare sempre la fattibilità dell'abbinamento finiture consultando l'interno del listino.

ALF UNO s.p.a. reserves the right to make any changes to products, measurements and materials at any time deemed useful for manufacturing and sales purposes. To stay up to date at all times, please visit our website www.valdesigncucine.it. FINISHES: The materials we use are selected among the most reliable products in terms of application and aesthetic rendering. Despite this, certain differences due to the very characteristics of materials such as natural wood finishes, glass and lacquers must be considered tolerable, as well as the hand-crafted nature of certain phases of the production process, which has always been one of our added values. In addition, some finishes may change over time, due to the effects of light and time. It is therefore important to specify whether there are replacements or completions in the order to assess the best way to proceed together. The finishes featured in this sample collection are purely indicative and are not available for all products. Please check in the price list if the finish is available for the chosen item. Orders will not be accepted for products with finishes not included in the price list. The colour shades and finishes illustrated herein are to be considered purely indicative. Always check the feasibility of finish combinations by consulting the price list contents.

art direction **Bruna Vaccher, Genny Canton** / graphic design **Genny Canton Studio** / digital image **Nudesign** / photo **Riccardo Munarin** / styling **Rosanna Bignucolo, Claudia Barberi** / separations **Luce srl** / print **Sincromia**



